



เครื่องมือพิเศษซ่อมรถยนต์

Automotive Tools

Catalog 2016



Other Products
เครื่องมือช่างอื่นๆ
 in Force General Tools
Catalog



ฟอर्स

FORCE

Professional Tools

Index

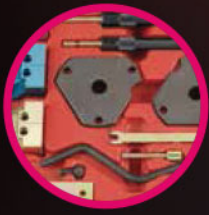

1-21
ENGINE
เครื่องยนต์

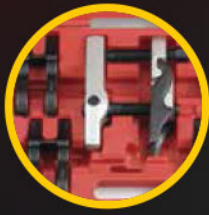

25-38
**BRAKE/
TRANSMISSION**
เบรคและเกียร์

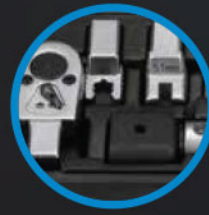

43-48
**PULLER/
TORQUE WRENCH**
เหล็กดูดและประแจทอร์ค

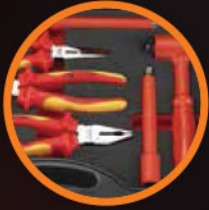

22-24
ELECTRICAL
ระบบไฟฟ้า



39-42
AUTO BODY
ตัวถังรถยนต์

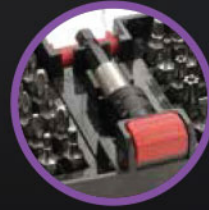

49-56
GENERAL
เครื่องมือทั่วไป



FORCE®

2pc 3/8" Torque adapter set ชุดข้อต่อทอร์กในตัว 2 ชิ้น

Content: 3/8" DR.

832 318...324 2-Torque adapter
18Nm; 24Nm



KT Code	Model	Weight (g)	Price
F131-K3021	K3021	500	2,590.-

13pc Spark plug maintenance kit ชุดเครื่องมือถอดประกอบหัวเทียน 13 ชิ้น

Content: 3/8" DR.

- 8323 18...24 2-Torque adapter 18Nm; 24Nm
- 802318 1-Flexible ratchet handle
- 807316M...20.6M 2-Magnetic spark plug socket 16; 20.6 mm
- 8043150 1-Extension 150mm-6"
- 61802 1-26 sizes Feeler gauges (SAE & Metric)
- 63001 1-Spark plug hole thread chaser
- 63004 1-14mm Spark plug hole rethreader
- 9U3001 1-Brass & Nylon scrape brushes
- 9G3101 1-Calibrated ignition tester (HEI system)
- 9G3102 1-Calibrated ignition tester (Standard system)
- 9G0107 1-Spark plug boot pliers



KT Code	Model	Weight (g)	Price
F131-K913G5	K913G5	2720	8,400.-

Spark plug hole rethreader ตัวซ่อมเกลียวหัวเทียนแบบ 2 ทาง

- Applying company with 13/16" standard deep socket.



KT Code	Model	Thread (mm)	Weight (g)	Price
F131-63001	63001	14&18	150	480.-
F131-63002	63002	12&14	135	470.-
F131-63003	63003	10&12	100	540.-

14mm Spark plug hole rethreader ตัวซ่อมเกลียวหัวเทียน 14 มม. เกลียวด้านเดียว

- Use it to clean and restore the threads on 14mm spark plug hole prior to installation of spark plug.
- Features extra-long neck for access to recessed spark plug cavities.
- Apply it accompanied with 3/8" drive or 5/8" standard socket.



KT Code	Model	Thread (mm)	Weight (g)	Price
F131-63004	63004	14	58	380.-

5pc Spark plug rethreader set ชุดเครื่องมือซ่อมเกลียวหัวเทียน 5 ชิ้น

- Repairing stripped or damaged threads in aluminum cylinder heads.
- Solid steel inserts replace damaged threads.



Content:

1pc 14mm Spark plug rethreader
4pc inserts 3/8"; 7/16"; 1/2"; 3/4" long



KT Code	Model	Weight (g)	Price
F131-64101	64101	144	790.-

3/8" DR. Magnetic long spark plug socket ลูกบ็อกซ์หัวเทียนยาว 3/8" (แม่เหล็ก)



KT Code	Model	Socket	l (mm)	Weight (g)	Price
F131-807325014M	807325014M	14mm	250	316	710.-
F131-807325016M	807325016M	16mm	250	344	810.-



Spark plug gauge

เกจวัดหัวเทียน

- This popular solid steel spark plug gauge is designed with a tapered edge for gauging spark plugs and with a flanged hole to adjust the side wire of plugs without pressuring center electrode. Marked in standard and metric sizes.
- Size range: 0.020" to 0.100" (0.5mm to 2.53mm)

KT Code	Model	Weight (g)	Price
F131-63008	63008	26	150.-

DR. Magnetic spark plug socket

ลูกบ็อกซ์หัวเทียนสั้น (แม่เหล็ก)

8073...M 8074...M

KT Code	Model	DR.	Socket	l (mm)	Weight (g)	Price
F131-807314M	807314M	3/8"	14mm	70	74	390.-
F131-807316M	807316M	3/8"	16mm	70	80	260.-
F131-807318M	807318M	3/8"	18mm	70	122	280.-
F131-807320.6M	807320.6M	3/8"	20.6mm	70	151	270.-
F131-807414M	807414M	1/2"	14mm	70	72	380.-
F131-807416M	807416M	1/2"	16mm	70	86	250.-
F131-807418M	807418M	1/2"	18mm	70	146	280.-
F131-807420.6M	807420.6M	1/2"	20.6mm	70	148	270.-

In-line spark plug tester

ไขควงทดสอบกระแสไฟหัวเทียน

- Handy pocket screwdriver type.
- Checks dead spark plugs in automotive.
- CE approved.

KT Code	Model	Weight (g)	Price
F131-88409	88409	65	460.-

Camshaft locking tool

เครื่องมือล็อกเพลาลูกเบี้ยว

- VW: POLO/CLASSIC, GOLF / BORA, BETTLE, CADDY (97-06).
- Enable replacing the timing belt without removing the cylinder head cover.

KT Code	Model	Weight (g)	Price
F131-903G10	903G10	2100	2,370.-

Universal timing gear holder

ค้ำจับเฟืองรากลั่น

- Used to hold cam gear while removing cam shaft bolt.
- Allows adjustment of cam gear once installation is completed
- Single sliding design makes it quick and easy to adjust.
- Three positions for wider application range.
- Range: 50 ~ 150 mm.

KT Code	Model	Weight (g)	Price
F131-9G0617	9G0617	-	2,380.-

1/2" Dr. Hand impact wrench

ค้ำตอกน็อตพู่เส้ย

- Special design to replace the harmonic balancer pulley.
- It will turn when you try to remove the center nut.
- Applicable: flywheels, pulleys, flanges and etc.

KT Code	Model	Weight (g)	Price
F131-9G0712	9G0712	1375	3,080.-



22pc Alternator repair kit set ชุดเครื่องมือซ่อมโอดชาร์จ 22 ชิ้น

- Removes and installs press-on-type belt drive accessory pulleys.
- Applicable: VW, Audi, Seat, Mercedes Benz, Renault, BMW, Ford Renault, Fiat, etc....
- Specification:
 - A. 17mm HEX Socket, B. 22mm HEX Socket
 - C. 22*28mm HEX Socket, D. 21*28mm HEX Socket
 - E. 19*28mm HEX Socket, F. 35mm Round W/4pin
 - G. 38mm HEX W/3pin, H. Ø17.6*15mm HEX*33T
 - I. Ø19.2*15mm HEX*33T, J. Ø19.3*22mm HEX*33T
 - K. 3/8" Dr.* M10x72mmL W/ Ø14*12mm HEX*31T
 - L. 1/2" Dr. * T50x110mmL W/ Ø19.5*17mm HEX*33T
 - M. 1/2" Dr. * M10x110mmL W/ Ø19.5*17mm HEX*33T
 - N. Bit H10 socket W/ 10mm hex drive end



KT Code	Model	Weight (g)	Price
F131-922G3	922G3	2169	4,250.-

17pc Clutch alignment tool set ชุดเครื่องมือนำศูนย์คลัทช์ 17 ชิ้น

- Essential for clutch installation on almost all cars and light-duty trucks. Align clutch plate properly by using tapered cones and pilot adapters.
- Includes seven fractional pilot adapters, one clutch disc centering adapter and one alignment shaft.
- Includes five metric pilot adapters, two clutch disc centering adapters and one alignment shaft.

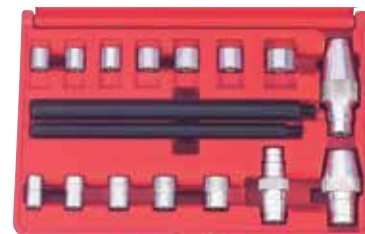
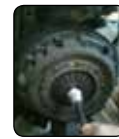

KT Code	Model	Weight (g)	Price
F131-917T2	917T2	1290	2,970.-

Adjusting tensioner belt set ประแจตั้งลูกกรอราวลิ้น

- Application: all VAG group.



KT Code	Model	Weight (g)	Price
F131-903G15	903G15	670	1,820.-

Belt tool kit for elastic-ribbed belts ชุดเครื่องมือติดตั้งสายพาน Elastic

- Suitable for engines with elastic ribbed belts such as Alfa Romeo, BMW, Chrysler, Fiat, Ford, Mercedes, PSA, Seat, Skoda, Smart, Volvo, VW-Audi...etc
- This tool set provides quick easy removal and installation of the new elastic ribbed belts required.



KT Code	Model	Weight (g)	Price
F131-902G9	902G9	567	2,660.-

Universal tensioning gauge for cam belts เกจวัดความตึงของสายพาน

- This tensioning gauge can be used to adjust the tension on the cam belts where the movement of the timing belt is measured by load.
- Suitable for use on cam belts with various belt thickness.
- Easy to use.
- Clear incremental marking with knurled knob for precise measurement.
- Dual scale allows reading from top or bottom of tool. (large and small numbers for compatibility)



KT Code	Model	Weight (g)	Price
F131-9G0804	9G0804	338.5	4,120.-

Flat band hose clamp pliers คีมหนีบเข็มขัดรัดท่อ แบบทัวไป

- Removes and installs new style flat band hose clamps.
- Jaws rotate to grip at any angle.



KT Code	Model	Weight (g)	Price
F131-62518	62518	250	680.-



Angled flat band hose clamp pliers

คีมหนีบเข็มขัดรัดท่อ แบบทำมุม

- Designed to remove and install flat band hose clamps in hard-to-reach areas. Pliers feature angled jaws with rotating tips to grip clamps at any angle. Locking latch securely holds clamp in position.

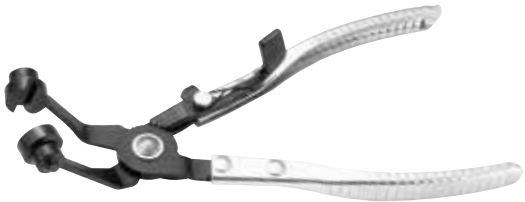



KT Code	Model	Weight (g)	Price
F131-62522	62522	227	850.-

Flexible hose clamp remover

คีมดึงเข็มขัดรัดท่อ แบบสายอ่อน

- For replacement of fuel, oil and water hose.
- Hose clamp with flexible 630mm wire.
- Convenient for working hidden areas and long distance.





KT Code	Model	Weight (g)	Price
F131-9G0201	9G0201	630	2,830.-

Hose clamp pliers

คีมล็อกเข็มขัดรัดท่อ

- Deep-slotted Jaws can remove and replace all size spring wire hose clamps and lock them safely in an position.

KT Code	Model	l (mm)	Weight (g)	Price
F131-6252807	6252807	180	370	1,520.-
F131-6252809	6252809	230	415	1,640.-

CLIC-R Collar pliers

คีมหนีบเข็มขัด แบบ Clic-R

- For releasing and refitting reusable hose clips.
- For type CLIC and CLIC-R.



KT Code	Model	Weight (g)	Price
F131-9G0104	9G0104	260	1,020.-

3/8" DR. Hose clip tool

ตัวหนีบเข็มขัดรัดท่อ

- Designed to fix the hose without removing sensors, duct, hose...etc. that are near the hose clamps.
- The end shape with trapezoidal teeth does not slip and allows various positions. (vertical, horizontal, diagonal...)
- Suits difficult work with pliers type tool of vehicle type.





KT Code	Model	Weight (g)	Price
F131-9G0120	9G0120	190	1,610.-

2pc Hose remover set

ชุดเครื่องมือถอดท่อแบบขงเกี่ยว 2 ชิ้น

- Allows the mechanic to easily free stuck or adhered automotive hoses without fear of hose damage or personal injury.
- Perfect for use on coolant, vacuum, oil and power steering hoses of all diameters.



KT Code	Model	Weight (g)	Price
F131-902G22	902G22	-	590.-



Hose removal pliers

คีมถอดท่ออย่าง

- For easy removal of 5/32" to 1/2" vacuum and fuel hoses.



KT Code	Model	Weight (g)	Price
F131-9G0105	9G0105	200	720.-

4pc Fluid line clamp set

ชุดเครื่องมือรัดท่อน้ำมัน ป้องกันการไหล 4 ชิ้น

- Conveniently pinch off fuel, vacuum, transmission, brake, heater lines and more.
- Sizes: 3/8" (~ø10mm), 1/2" (~ø15mm), 1" (~ø25mm) & 1-3/4" (~ø45mm)



KT Code	Model	Weight (g)	Price
F131-904G8	904G8	470	1,220.-

Fluid hose clamp

คีมหนีบท่อสายเบรก/สายน้ำมัน

- Completely or partially closes flexible brake, fuel, and vacuum, fluid line. All steel construction with adjustable locking collar.

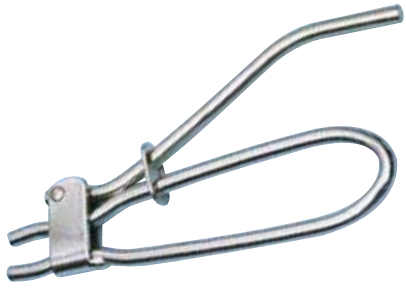

KT Code	Model	Weight (g)	Price
F131-9G0110	9G0110	165	690.-

3pc Hose pinching pliers

ชุดคีมหนีบท่ออ่อนน้ำมันเบรก/ท่ออ่อนส่งน้ำมัน 3 ชิ้น

- Smooth, rounded jaw, edged prevent damage to internal hose reinforcement.
- Quick and simple, one handed use.
- Size: Hose clamp for up to 10mm, 15mm, 24mm line diameter

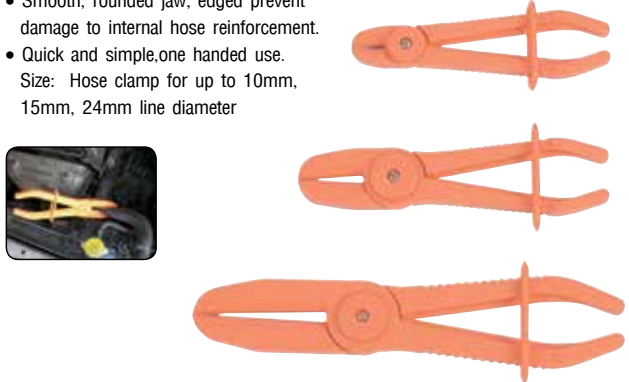

KT Code	Model	Weight (g)	Price
F131-903G12	903G12	300	890.-

3pc Hose clamp gripper set 90°

ชุดคีมหนีบท่ออ่อนแบบ 90 องศา 3 ชิ้น

- Made of heat resistant nylon.
- Rounded jaw edges prevent damage to internal hose reinforcement.
- Features locking mechanism for simple one-handed use.
- Suitable for brake, coolant, fuel & vacuum hoses.

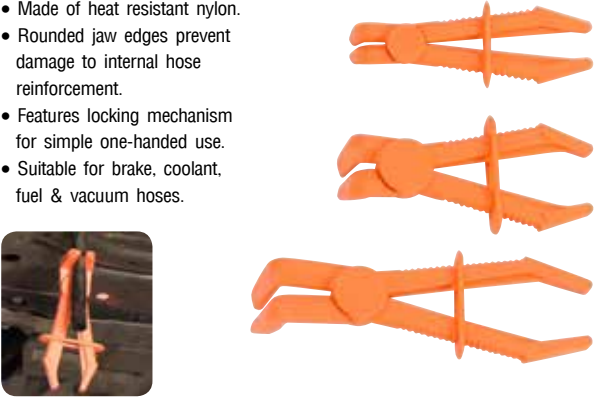

KT Code	Model	Weight (g)	Price
F131-903G18	903G18	375	1,000.-

Locking pinch-off pliers 280mmL

คีมลือคจับท่ออ่อน ยาว 280 มม.

- Pinch off and lock on butane gas lines and copper tubing.



KT Code	Model	Weight (g)	Price
F131-9G0115	9G0115	475	1,640.-



Battery / anti-freeze cleaning fluid tester

เครื่องตรวจวัดคุณภาพน้ำยาหม้อน้ำ

Testing range:
 Battery fluid: 1.100~1.400
 Ethylene glycol °C: -5(12.4%) ~ -60(66.6%)
 propylene glycol °C: -5(14.8%) ~ -50(62.4%)

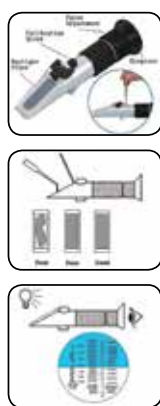



KT Code	Model	Weight (g)	Price
F131-9G0303	9G0303	400	5,310.-

Cylinder leakage tester

เครื่องมือทดสอบการรั่วของกระบอกลูกสูบ

- This set could test if the wall of cylinder is abrasive.
- The CO2 test liquid is checking volume of CO2 existing in radiator in the car.
- Have blue color of test liquid mixed with stem in the radiator if the liquid become yellow or green then it means that the wall of cylinder is abrasive.
- It offers simple, quick and correct test.
- The CO2 test liquid is recyclable.





KT Code	Model	Weight (g)	Price
F131-905G10	905G10	1200	5,090.-

Cooling system vacuum purge & refill kit

ชุดเครื่องมือเปลี่ยนถ่ายน้ำในหม้อน้ำ แบบสุญญากาศ

- Designed to pump radiator and cooling system to vacuum.
- Simply refill coolant into radiator without air.
- Gauge: 0~76 cm-Hg, 0~30 in-Hg

KT Code	Model	Weight (g)	Price
F131-906G2	906G2	1400	4,620.-

Anti-freeze tester

ปรอทวัดอุณหภูมิหม้อน้ำ

- Avoid winter freeze-ups and summer boil-over.
- Test all permanent (Ethylene Glycol) solutions with radiator hot or cold.
- Two scales show freeze point of radiator solution and boiling point of summer coolant.



KT Code	Model	Weight (g)	Price
F131-9G4001	9G4001	130	410.-

Universal radiator pressure tester kit

ชุดเครื่องมือวัดแรงดันหม้อน้ำรถยนต์

- Designed to test the leaks of cooling system.
- Suit for: Suzuki, Isuzu, Lexus, Opel, Peugeot, Jeep, Rover, Citron, Nissan, Mitsubishi, Mazda, Subaru, BMW, Renault, Fiat, Alfa Romeo, Toyota, Honda, Ford, GM, Chrysler, VW, Audi, Volvo, Saab, Mercedes Benz, Infiniti, Geo, Truck
- Gauge: 0~35 PSI, 25 bar





KT Code	Model	Weight (g)	Price
F131-914G1	914G1	3875	15,170.-

Automotive noise finder

เครื่องมือทดสอบเสียงเครื่องยนต์

- This is a portable automotive noise finder which can quickly detect source or location of noises emanated from bearing, gear, valve, valve body, crankshaft, cylinder, gearbox, car body and so on after starting engine.
- It helps the serviceman to pinpoint the actual noise part and severity even in severe ambient noise.



KT Code	Model	Weight (g)	Price
F131-902G11	902G11	225	1,960.-



» Mechanic's stethoscope ชุดหูฟังเครื่องยนต์

- Provides a fast and easy way to locate noises in engines or bearings and other moving parts.
- Plastic earphones shut off outside noises.
- Aluminum alloy probe/needle for finding the exact location of specific noises.
- High quality surgical PVC & rubber parts for increased sound definition.
- Instrument is shockproof.
- Ideal for pinpointing unusual vibrations or suspected leaks (valves, piston rings, gaskets etc.)
- Supplied with a rubber trumpet for checking vacuum & pressure flow.
- Useful for synchronizing multi carburetors.



KT Code	Model	Weight (g)	Price
F131-9G2201	9G2201	200	1,250.-

» Mechanic's stethoscope ชุดหูฟังเครื่องยนต์

- Provides a fast and easy way to locate noises in engines or bearings and other moving parts.
- Ideal for pinpointing unusual vibrations or suspected leaks (valves, piston rings, gaskets etc.)





KT Code	Model	Weight (g)	Price
F131-9G2204	9G2204	200	790.-

» Vacuum pump / Brake bleeding kit ชุดเครื่องมือทำแรงดันและแรงดูด / ชุดไล่ลมเบรก

- Check vacuum operated components on cars and trucks.
- Allows you to bleed brake fluid without the mess.

Contents:

1. Vacuum pump (0-30 in.Hg)
2. Connection hose. (600mm x 2 pcs)
3. 200ml fluid reservoir bottle.
4. Fluid transfer and storage lids x 2 pcs.
5. Connection accessories:
(Rubber cupped adapter)
(Accessory hoses: 75mm x 2 pcs)
(Accessory hoses: 95mm x 2 pcs)

KT Code	Model	Weight (g)	Price
F131-906G3	906G3	1830	4,410.-

» Turbo system tester kit ชุดเครื่องทดสอบแรงดันเทอร์โบ

- For fast diagnostics of the charging air system.
- Enables time saving and appropriate determination of leaky intercoolers and invisible cracks in charging air hoses.
- Four pairs of stepped adapters : 85 - 90, 75 - 80, 65 - 70, 55 - 60 mm



KT Code	Model	Weight (g)	Price
F131-909G7	909G7	725	6,290.-

» Gas cylinder compression tester set ชุดเครื่องมือวัดกำลังอัดในกระบอกลูกสูบ

Gauge: 0-300 PSI, 0-21 kg/ cm2

Contents:

Air gauge with quick coupling & release valve. High-tension connecting pipe with safety lock coupling. Crank shaft type test pipe with rubber plug.

Transvers axis test pipe with rubber plug.



M10*1.0 Adapter
M12*1.25 Adapter
M14*1.25 Adapter
M18*1.5 Adapter



KT Code	Model	Weight (g)	Price
F131-908G1	908G1	1160	3,910.-

» Oil pressure tester set ชุดเครื่องมือวัดแรงดันน้ำมันเครื่อง 12 ชิ้น

- Helps to diagnose worn oil pumps and engines, faulty oil pressure switches and warning indicators.
- Accurately tests oil pump pressure, switch & warning indicators.
- Large clear dual scaled gauge.
- Quick coupling adapters, with shut-off valve, for speed & security.
- Permanently oil primed, long, flexible hose.
- Gauge: Scale: 0~150 PSI, 0~10 kg/ cm2, 0~10 bar
Thread: R/18 Din 2999, 1/8 x 27 Npt, 1/4 x 18 Npt, 3/8x 20 Unf, 1/2 x 20 Unf, M10 x10, M12 x1.5, M14 x1.5, M16x 1.5, M18 x1.5, 90° Elbow



KT Code	Model	Weight (g)	Price
F131-912G1	912G1	1830	6,700.-



Gasoline engine injecting pressure tester set

ชุดเครื่องมือวัดแรงดันหัวฉีด เบนซิน

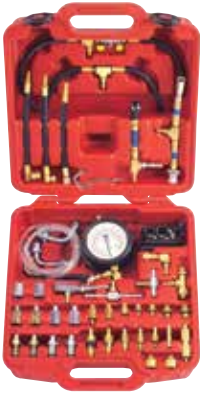
- Gauge: 0~120 PSI 8 bar
- This tester is an assembly of fuel injection pressure test.
- The related adaptors are suitable for cars of American, Japanese and European systems.

KT Code	Model	Weight (g)	Price
F131-946G1	946G1	5180	19,180.-

Cylinder leakage tester

ชุดเครื่องมือทดสอบรอยรั่วกระบอกลูกสูบ

- PSI&BAR percentage gauge
- 26" extra long hose
- Allow you to accurately diagnose engine problems such as bad valves, worn rings.
- Cracked cylinder walls and blown gaskets.
- Works from shop airline and has 14&18mm adaptor fittings to fit most engines.
- Blow-by readings shown in percentages.
- Dual gauges allow mechanic to monitor input line pressure.
- Supplied in plastic blow mold case.
- Gauge: 0~100 PSI 7 bar



KT Code	Model	Weight (g)	Price
F131-902G3	902G3	1100	6,360.-

Transmission & engine oil pressure tester

ชุดเครื่องมือวัดแรงดันน้ำมันเครื่อง

- Designed to check engine oil pressure in automatic transmissions and engines in both cars and trucks.
- With two easy to read dual scale gauges. Both of two gauges with quick set-up. Complete with 6ft(1.8m) of oil proof hose, nine adaptor fittings, and instructions.
- Dual gauge readings:
A: 0 to 400psi (0 to 28bar)
B: 0 to 150psi (0 to 10bar)
- Gauge diameter: 2.5"





KT Code	Model	Weight (g)	Price
F131-912G2	912G2	1400	4,860.-

Diesel engine compression test set

ชุดเครื่องมือวัดกำลังอัดเครื่องยนต์ดีเซล

- Features 600psi (40bar) gauge with large rubber bumper, straight and right angled quick connect fittings and an extensive range of glow plug and injector adaptors.
- This kit will cover most modern car, van, truck, bus, agricultural and marine engines.
- Glow plug adaptors: Wide range of Alfa, BMW, Chrysler, Daewoo, Fiat, Ford, Hyundai, Isuzu, Land Rover, LDV, Mazda, Mercedes, Mitsubishi, Nissan, Opel, PSA, Renault, Saab, Suzuki, Toyota, VAG, Vauxhall, Volvo diesel engines.
- Injector Adaptors: M20, M22, M24 & Ford Stanadyne Injectors plus Clamp-On Injectors..



KT Code	Model	Weight (g)	Price
F131-937G1	937G1	-	20,610.-

Diesel injector nozzle extractor set

ชุดเครื่องมือถอดหัวฉีด ดีเซล

- Extraction injectors without dismantling the engine.
- Extraction Bosch injectors.
- For CDI engines 2.1 I and 2.2 I.
- Application: Vito, Sprinter, Viano, C and E Class, CLC, CLK.



KT Code	Model	Weight (g)	Price
F131-903G19	903G19	2580	5,300.-

Injector nozzle extractor with spindle

ชุดเครื่องมือถอดหัวฉีดเครื่องยนต์

- This special-designed diesel injector puller set is ideal for the need to remove stubborn diesel injector.
- No need to remove cam cover and the use of slide hammer, either.
- Application: Mercedes C-Class, E-class, Sprinter Vehicles and Chrysler Grand Cherokee 27crd (00).



KT Code	Model	Weight (g)	Price
F131-903G17	903G17	1291	4,210.-



3pc Pre-heater plug puller set ชุดเครื่องมือทำความสะอาดหัวเผาแบบ 3 ชิ้น

- To ream out and clean the bore between the glow plug and pre-combustion chamber.
- Application : pre-heater plugs with 10mm, glow plug 6 and 7mm.



KT Code	Model	Weight (g)	Price
F131-903G16	903G16	570	4,080.-

Glow plug removal and puller set ชุดเครื่องมือถอดหัวเผาเครื่องยนต์ 27 ชิ้น

- Simplifies the assembly and disassembly and professional repair of glow plug thread.
- Suitable for most injectors.
- Assembly and disassembly of glow plugs and repair glow plug threads.
- Extractor for fixed glow plugs.
- Step drill to drill out damaged glow plugs 7 x 5.5 mm and 9 x 5.5 mm.
- Taps M8 x 1.0, M10 x 1.0 and 1/4"-28UNF for repairing glow plug threads.
- Tap holder.
- E10 socket.



KT Code	Model	Weight (g)	Price
F131-927G3	927G3	1750	16,250.-

1/4"DR. Glow plug impact socket set ชุดปืนลม 1/4" ถอดหัวเผาเครื่องยนต์ดีเซล

- A torque air impact wrench set and designed for the diesel engine glow plugs which hard to removal.
- Special long-reach 8 mm, 9 mm 10 mm, 11 mm and 12 mm sockets for ease of access.
- Also includes: short and long extension, universal joint and special 1/4" air impact wrench.



KT Code	Model	Weight (g)	Price
F131-909G6	909G6	1850	7,370.-

Injector sealing seat cleaning & milling set ชุดเครื่องมือทำความสะอาดหัวฉีดซิลกันรั่ว

- This is the optimized version of the cleaning and milling tool set.
- The advantages are clearly obvious.
- Can be used with HDI engines, diesel direct injection and common rail engines with BOSCH and DELPHI injectors.
- Shaft cleaning by brushes with machine drive, sealing seat cleaning with cutter 120° Ø21mm; 17mm stepped, miller 0° Ø17mm continuous, miller 0° Ø19mm; 17.0mm; 15.0mm stepped.

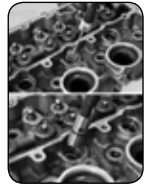

KT Code	Model	Weight (g)	Price
F131-921G2	921G2	1700	11,570.-

9pc Pre-heater plug tools ชุดเครื่องมือทำความสะอาดหัวเผาแบบ 9 ชิ้น

- To ream out and clean the bore between the glow plug and pre-combustion chamber.
- Size: M12 x 1.25, M10, pre-heater plugs with 10mm across ats.
- Fasten the glow plug with the correct torque
- 1/4" DR. universal socket size: 8, 9, 10, 12 mm



Thread Diameter	Tightening Torque
8mm	8-15Nm(0.8-1.5Kgm)
9mm	15-20Nm(1.5-2.0Kgm)
10mm	15-20Nm(1.5-2.0Kgm)
12mm	20-25Nm(2.0-2.5Kgm)

KT Code	Model	Weight (g)	Price
F131-K909G4	K909G4	1650	9,410.-

Valve spring compressor ซีแคมบิกคสปริงวาล์ว

- For large engines, most suitable for commercial vehicles and general garage use.
- Jaw opening 70-200mm, Throat clearance 250mm.





KT Code	Model	Weight (g)	Price
F131-62101	62101	3300	2,840.-



Valve spring compressor ซีแคมปิดสปริงวาล์ว

- For overhead cam engines, specially designed for O.H.C. engines.
- Jaw opening 60-155mm, Throat clearance 150mm.

KT Code	Model	Weight (g)	Price
F131-62102	62102	1630	1,510.-

Valve spring compressor ชุดซีแคมปิดสปริงวาล์ว

Universal overhead cam Applying for most popular cars engines, including AUDI, CHRYSLER, INFINITI, HONDA, HYUNDAI, LEXUS, MAZDA, MITSUBISHI, NISSAN, PORSCHE, SATURN, TOYOTA, VOLVO and VOLKSWAGEN.

KT Code	Model	Weight (g)	Price
F131-62105	62105	3500	3,940.-

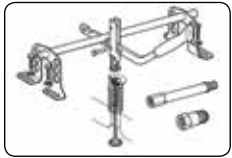
Valve spring compressor ซีแคมปิดสปริงวาล์ว



- For small and medium engines.
- Jaw opening 68-130mm, Throat clearance 150mm.



KT Code	Model	Weight (g)	Price
F131-62103	62103	1220	1,180.-

Valve spring compressor ซีแคมปิดสปริงวาล์ว



- Compresses overhead valve springs with rocker arm studs.
- This tool can be used with the head either on or off the engine.
- Jaws adjust to fit most overhead valve engines.
- Adjustable handle allows for clearance in tight areas.

KT Code	Model	Weight (g)	Price
F131-62106	62106	740	1,140.-

Valve spring compressor ซีแคมปิดสปริงวาล์ว

- For multi-valve petrol and diesel engines, specially designed for difficult access and deep-seated multi-valve cylinder heads.
- Jaw opening 45-145mm, Throat clearance 240mm.

KT Code	Model	Weight (g)	Price
F131-62104	62104	2650	2,940.-

Valve spring compressor ซีแคมปิดสปริงวาล์ว

- Capacity 55-175mm, throat clearance 165mm designed for use on Multi-Valve Petrol and diesel engines with deep Seated valves.
- Collet release adapters: Restricted access adapter, 25mm, 30mm
- Suitable for general use on a wide
- Range of OHC, OHV, and CVH engines. Universal model with unique
- Dual cam-action, parallel lift, and Automatic locking. reversible Jaw/Adaptor.



KT Code	Model	Weight (g)	Price
F131-62107	62107	1650	2,990.-



Valve spring compressor ซีแคมปิดสปริงวาล์ว

- For large engines & diesel engines
- Unique 'Direct Action' compressor lever gives improved visibility & ease of use in areas of difficult access.
- Collet release adapters: Restricted access adapter, 25mm, 30mm
- Jaw opening 35-142mm, Throat clearance 150mm.



KT Code	Model	Weight (g)	Price
F131-62108	62108	2000	3,130.-

Valve stem seal ring pliers คีมถอดซีลแหวนวาล์ว

- Long neck designed to reach into confined area of the seal to grip it for removal.
- Gripping serration allows them to grasp both original equipment & aftermarket seals regardless of the configuration.



KT Code	Model	Weight (g)	Price
F131-9G0102	9G0102	380	750.-

Universal valve-spring compressor tool ชุดเครื่องมือกดสปริงวาล์ว

- Suitable for the replacement of valve springs and valve stem oil seals without the need to remove the cylinder head
- Application: Opel, BMW, Seat, VW, Audi, Hyundai, Toyota, Ford 16V, Renault 19 and Clio.



KT Code	Model	Weight (g)	Price
F131-908G7	908G7	1600	4,320.-

Extra long valve stem seal ring pliers คีมถอดซีลแหวนวาล์ว ปากยาว

- For removing valve stem seals in multi-valve engines.
- Jaw longitudinal-toothed avoiding slipping down.
- For deeply levelled valve stem seals.



KT Code	Model	Weight (g)	Price
F131-9G0103	9G0103	380	780.-

3pc Valve keeper installing & pick-up tool set ชุดเครื่องมือใส่ตัวประกบวาล์ว 3 ชิ้น

- This tool holds the valve keepers in its magnetic jaws so you can easily maneuver the keepers into the valve stem grooves for installation.
- Easily reaches into recessed spring pocket to retrieve released valvekeepers.
- Retrieves small parts from any recessed or hidden area.



Contents:

- 3 pcs valve keeper installing tool
- Flexible magnetic pick-up tool



KT Code	Model	Weight (g)	Price
F131-903G1	903G1	320	1,830.-

Vacuum cup valve grinder ชุดค้ำบดวาล์ว

- For grinding flat head, un-slotted valves.
- 1-1/8" and 1-3/8" diameter cups for larger valves.
- 5/8" and 13/16" diameter cups for smaller valves.



KT Code	Model	Weight (g)	Price
F131-902G7	902G7	100	550.-



Feeler Gauges

ฟีลเลอร์เกจ 20 ใบ

- 20 Blades metric feeler gauge
- Thickness 0.05-1.00mm
- Length 105mm



KT Code	Model	Weight (g)	Price
F131-618	618	104	310.-

1/2"DR.100mm Cylinder head bolt tool

ลูกบิดข้อเดียวสำหรับสลักยึดฝาสูบเครื่องยนต์ ยาว 100 มม.

- Applications: FIAT
- 1/2" DR. 100mm.
- For cylinder head bolts.



KT Code	Model	Socket	l (mm)	Weight (g)	Price
F131-34810009	34810009	M9	100	95	200.-
F131-348100095	348100095	M9.5	100	102	310.-
F131-34810010	34810010	M10	100	108	200.-
F131-34810012	34810012	M12	100	151	230.-
F131-34810014	34810014	M14	100	187	270.-

9pc Offset feeler gauge

ฟีลเลอร์เกจ 9 ใบ แบบโค้ง

- Size: 0.009"; 0.015"; 0.016"; 0.017"; 0.018"; 0.019"; 0.020"; 0.021"; 0.026"
- Decimal sizes and metric equivalents on each blades.
- Blades LxW: 4" x 1/2" (100 x 13mm)



KT Code	Model	Weight (g)	Price
F131-61803	61803	104	280.-

Torque angle meter (clip)

ตัวนับวัดแรงบิดแบบของศา

- 9G1801 is used with 1/2" DR.
- Commonly used for tightening head bolts and other bolts where a torque angle is required.



KT Code	Model	Weight (g)	Price
F131-9G1801	9G1801	500	1,230.-

3pc Scraper knife set

ชุดเหล็กขูดประเก็น 3 ขนาด

- Size 15, 20, 30 mm
- Stainless steel, heat treatment of knife
- High grade wooden grip
- Sharp tip



KT Code	Model	Weight (g)	Price
F131-903M1	903M1	200	1,270.-

Torque angle meter (magnetic)

แม่เหล็กวัดแรงบิดแบบของศา

- 9G1802 is used with 1/2"DR.
- Commonly used for tightening head bolts and other bolts where a torque angle is required.



KT Code	Model	Weight (g)	Price
F131-9G1802	9G1802	495	1,230.-

Brake / Engine cylinder hone

เครื่องมือขัดกระบอกลูกสูบและกระบอกเบรค 3 ขา

- Flexible shaft with an adjustable honing tension capacity: 3/4" ~2-1/2"
- Stone size: 28.5 x 5 x 3mm (3pc) (Stone item number : 9G0902S)
- Sleeve makes insertion in cylinder easy and protects stones when not in use.
- Collar prevents stone breakage.
- Fine surface stones: 9G0902SF.
- Coarse surface stones: 9G0902SC.



KT Code	Model	Weight (g)	Price
F131-9G0902	9G0902	120	730.-

Piston ring compressor

ชุดเครื่องมือรัดแหวนลูกสูบ

- Install pistons from 2-7/8" to 4-3/8" (73 - 111mm) and 4-7/8" to 5-1/8" (124 - 130mm)
- Ratcheting lock allows the bands to compress in small increments.
- Can be used parallel vertically perpendicular horizontally.
- Set includes pliers and 7 bands.

Contents :

- 1pc Ratchet pliers
- 1pc Band size 2-7/8" to 3-1/8"
- 1pc Band size 3-1/8" to 3-3/8"
- 1pc Band size 3-3/8" to 3-5/8"
- 1pc Band size 3-5/8" to 3-7/8"
- 1pc Band size 3-7/8" to 4-1/8"
- 1pc Band size 4-1/8" to 4-3/8"
- 1pc Band size 4-7/8" to 5-1/8"



KT Code	Model	Weight (g)	Price
F131-62006	62006	1425	3,480.-

Piston ring compressor

ชุดเครื่องมือรัดแหวนลูกสูบ

- Install pistons from 2-7/8" to 4-3/8" (73-111mm)
- Ratcheting lock allows the bands to compress in small increments.
- Can be used parallel or perpendicular to the cylinder block.
- Set includes pliers and 6 bands.



Contents :

- 1pc Ratchet pliers
- 1pc Band size 2-7/8" to 3-1/8"
- 1pc Band size 3-1/8" to 3-3/8"
- 1pc Band size 3-3/8" to 3-5/8"
- 1pc Band size 3-5/8" to 3-7/8"
- 1pc Band size 3-7/8" to 4-1/8"
- 1pc Band size 4-1/8" to 4-3/8"



KT Code	Model	Weight (g)	Price
F131-62001	62001	1487	2,860.-

Piston ring compressor

เครื่องมือรัดแหวนลูกสูบ



KT Code	Model	mm	l (inch)	Weight (g)	Price
F131-6202080	6202080	40-80	2	156	580.-
F131-6203125	6203125	53-125	3	310	470.-
F131-6203175	6203175	90-175	3	365	690.-
F131-6204125	6204125	90-125	4	335	810.-
F131-6204175	6204175	90-175	4	380	550.-
F131-6206175	6206175	90-175	6	600	930.-

Piston groove cleaner

เครื่องมือทำความสะอาดร่องแหวนลูกสูบ

- Designed for cleaning the piston slots.
- Piston slot size: 2, 2.5, 3, 3.5 mm



KT Code	Model	Weight (g)	Price
F131-62003	62003	570	2,200.-

Chain oil filter wrench (1/2" DR.)

ลูกบิดข้อโซ่ 1/2" ถอดไส้กรองน้ำมันเครื่อง

- 1/2" sq. driver or 13/16"(21mm) open end spanner.
- Suitable for filters up to 120mm diameter.



KT Code	Model	Weight (g)	Price
F131-61901	61901	262	360.-



» Piston ring installer

คีมถ่างแหวนลูกสูบ

- Save by reducing ring breakage.
- Tapered jaws to remove and install most passenger car and light truck rings from 3/64" to 1/4" (1.2mm ~6.3mm)





KT Code	Model	Weight (g)	Price
F131-62002	62002	135	420.-

» Filter chain wrench

ประแจถอดกรองน้ำมันเครื่อง แบบโซ่

- Suitable for filter up to 40mm - 120mm diameter.





KT Code	Model	Weight (g)	Price
F131-61911	61911	410	710.-

» Piston ring pliers

คีมถ่างแหวนลูกสูบ

- 62302 is applied to truck.

KT Code	Model	W mm	L (inch)	Weight (g)	Price
F131-62301	62301	55-100	3	330	780.-
F131-62302	62302	110-160	3	420	1,150.-
F131-62303	62303	80-120	2.5	170	1,020.-

» Strap oil filter wrench (1/2" DR. & 3/8" DR.)

สายรัดถอดไส้กรองน้ำมันเครื่อง 1/2" & 3/8"

This robust quality strap wrench is capable of removing filters up to 300mm diameter on cars, vans and trucks.

- The design of this wrench makes it ideal for areas where clearance is restricted.
- The dual drive allows you more flexibility. Besides, the wrench can be used in conjunction with a 13/16"(21mm) open spanner.



KT Code	Model	Weight (g)	Price
F131-61903	61903	408	700.-

» Oil filter strap wrench

สายรัดถอดไส้กรองน้ำมันเครื่อง



KT Code	Model	L (mm)	Weight (g)	Price
F131-619	619	150	310	510.-

» Three-legged oil filter wrench

ตัวถอดไส้กรองน้ำมันเครื่อง แบบ 3 ขา / 2 ทาง ทรงขากกม

- Removes all oil filters from 2-1/2" to 4-5/16" (65mm to 110mm) in diameter.
- Used with 3/8" square drive tools.







KT Code	Model	Weight (g)	Price
F131-61904	61904	590	940.-

Three-legged two way oil filter spiral wrench
ตัวถอดไส้กรองน้ำมันเครื่อง แบบ 3 ขา / 2 ทาง ทรงขาแบน

- Fits 1/2" & 3/8" Square Drive Ratchet Handle
- Operated By 21 mm Hex Adaptor: 1/2" Sq. X 3/8" Sq.
- All Chrome Plated. 3-Leg Two Way
Operated Range: 63 ~ 102 mm.

KT Code	Model	Weight (g)	Price
F131-61904A	61904A	415	790.-

Swivel handle oil filter wrench
ตัวถอดกรองน้ำมันเครื่อง แบบสายรัด



KT Code	Model	l (mm)	Weight (g)	Price
F131-61906073	61906073	2-3/8" to 2-7/8" (60mm - 73mm)	335	630.-
F131-61906085	61906085	2-7/8" to 3-3/8" (73mm - 85mm)	372	650.-
F131-61906095	61906095	3-3/8" to 3-3/4" (85mm - 95mm)	389	670.-
F131-61906111	61906111	3-3/4" to 4-3/8" (95mm - 111mm)	408	700.-

Strap oil filter wrench
ประแจถอดกรองน้ำมันเครื่อง แบบสายพาน

- With non-slip rubber-fabric strap
- Especially suitable for plastic pipes
- Strap length: 420 mm
- Capacity: 130 mm diameter

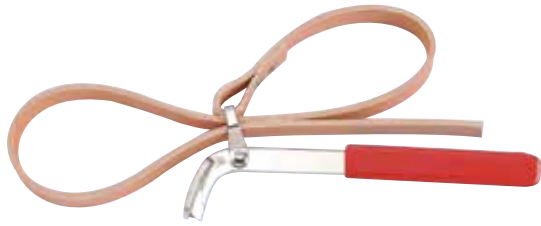

KT Code	Model	Weight (g)	Price
F131-61908	61908	338	860.-

Adjustable oil filter wrench
ประแจถอดไส้กรองน้ำมันเครื่อง แบบสายโลหะ

- Capacity: 80-110 mm diameter



KT Code	Model	Weight (g)	Price
F131-61909	61909	350	1,020.-

Strap wrench
ประแจถอดไส้กรองน้ำมันเครื่อง แบบสายรัด

- 12" Aluminum handle
- 34" Strap



KT Code	Model	Weight (g)	Price
F131-61912	61912	320	1,020.-

Oil filter wrench
ประแจถอดไส้กรองน้ำมันเครื่อง

- Spring steel strip
- Aluminium diecast





* Spare diecast (band) available.61910-D/61910L-D

KT Code	Model	Capacity (mm)	Weight (g)	Price
F131-61910	61910	65-110	210	370.-



Oil filter pliers

คีมปากกขยายถอดไส้กรองน้ำมันเครื่อง

KT Code	Model	Size mm	l (inch)	Weight (g)	Price
F131-639250	639250	60-90	10	354	670.-
F131-639300	639300	85-115	12	379	740.-
F131-639365	639365	100-140	14	550	2,480.-

Cup type oil filter wrench set

ชุดฝาถอดไส้กรองน้ำมันเครื่อง



61515



61916



61917



KT Code	Model	No. of set	Weight (g)	Price
F131-61915	61915	15pcs.	3200	2,820.-
F131-61916	61916	16pcs.	3940	3,890.-
F131-61917	61917	30pcs.	7060	6,510.-

Oil filter wrench for Toyota / Lexus

ฝาถอดไส้กรองน้ำมันเครื่องแบบ 3 เขี้ยวสำหรับ Toyota / Lexus

- Special designed for plastic oil filter cap of Toyota and Lexus
- Size: 3/8"DR. , 64.5 mm, 14PT
- Applicable: Allion, Auris, Corolla axio, Corolla fielder, Corolla rumion, Isis, Ist, Noah, Premio, Prius, Wish, RAV4, Yaris, ES350, GS300, GS350, GS450h, IS250, IS350, LS460, LS600h, RX350





KT Code	Model	Weight (g)	Price
F131-631B02	631B02	-	770.-

Oil filter wrench

ฝาถอดไส้กรองน้ำมันเครื่อง

- Can operate with 1/2" drive.





KT Code	Model	mm	Pl.	Application	Price
F131-6316514	6316514	64	14	TOYOTA, NISSAN	530.-
F131-6316714	6316714	67	14	FORD, MAZDA	530.-
F131-6317314	6317314	73	14	TOYOTA, NISSAN	530.-
F131-6317330	6317330	73	30	GM, FORD	530.-
F131-6317315	6317315	73	15	GM, FORD, MITSUBISHI	530.-
F131-6317414	6317414	74	14	BMW, AUDI, WOLKSWAGEN, OPEL, AUSTIN	530.-
F131-6317408	6317408	74	8	FIAT	530.-
F131-6317415	6317415	74	15	GM, CHRYSLER, ROVER	530.-
F131-6317515	6317515	75	15	GM, CHRYSLER	530.-
F131-6317612	6317612	76	12	FORD, MAZDA	530.-
F131-6317815	6317815	78	15	NISSAN, TOYOTA, HONDA ACCORD	530.-
F131-6317915	6317915	79	15	DAIHATSU, FORD	530.-
F131-6318418	6318418	84	18	PEUGEOT, CITROEN, RENAULT	590.-
F131-6318614	6318614	86	14	MAZDA, MITSUBISHI	590.-
F131-6318915	6318915	89	15	HONDA, MITSUBISHI	590.-
F131-6319115	6319115	91	15	TOYOTA, NISSAN	620.-
F131-6319112	6319112	91	12	CITROEN, PEUGEOT, RENAULT	620.-
F131-6319115B	6319115B	91	15	GM, FORD, CHRYSLER, LANCIA, FIAT	620.-
F131-6319215	6319215	92	15	HONDA, TOYOTA	620.-
F131-6319515	6319515	95	15	GM, FORD, CHRYSLER, ALFA	620.-
F131-63110115	63110115	101	15	DAIHATSU, MAZDA, MITSUBISHI, TOYOTA	670.-

9pc Cup type oil filter wrench kit

ชุดฝาถอดไส้กรองน้ำมันเครื่อง 9 ชิ้น

- Use with 3/8" DR. or 21mm wrench.
- Size: 27/6P, 32/6P, 36/6P, 76/14P, 75.6/14P, 86/16P, 76/12P, 93/15P
- With a specialized 21mm wrench
- Suitable for Benz, BMW, Volvo, VW, Fiat, Renault, Honda, Mazda, Nissan, Toyota, etc.





KT Code	Model	Weight (g)	Price
F131-61922	61922	2000	3,920.-



8 & 10mm Oil service wrench

ประแจถ่ายน้ำมันเกียร์และเฟืองท้าย

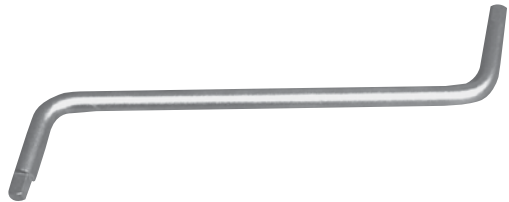
Chrome-vanadium, chrome-plated with 8 and 10 mm outside square drive for various French passenger cars, oil drain plug on oil pan, gearbox, differential.

KT Code	Model	Weight (g)	Price
F131-9U0706	9U0706	344	610.-

15pc 3/8"DR. Drain nut

ชุดเครื่องมือเปลี่ยนถ่ายของเหลว 15 ชิ้น

The drain nut set has different external shape to fit different requirements. We offer also the drain nut set without driver.



- 9.5mm
- 10mm
- 8, 9.5, 11, 12, 13 mm
- 8, 9, 9.5, 10, 12, 14, 17 mm

KT Code	Model	Weight (g)	Price
F131-915G2	915G2	750	2,560.-

12pc Auto kit set

ชุดจุกเกลียวถ่ายน้ำมันเครื่อง 12 ชิ้น

Contents:

- 5061-1 6-Fill / Drain plug key 5/16"Hex - 3/8"Hex
- 5061-2 8mmSq. - 3/8"mmSq.
- 5061-3 11mmSq. - 12mmHex
- 5061-4 13mmSq. - 14mmHex
- 5061-5 17mmHex - 1/2"Hex
- 5061-6 8mmHex - 10mmHex
- 8074 16M...20.6M 1/2"DR. Magnetic spark plug socket 16mm; 20.6mm
- 810421 Plug key holder 1/2"(F)x21mm(F)
- 617 Telescope mirror stick / magnetic pick-up
- 618 20pc feeler gauges 0.05mm to 1mm
- 619 Oil filter strap wrench



KT Code	Model	Weight (g)	Price
F131-5122	5122	1970	2,740.-

1/2" DR. Drain nut socket bit (M16H)

ลูกบ็อกซ์น็อตถ่ายน้ำมันเกียร์ Audi/VW

- For removal and replacement of the gear box drain plug Audi A3, A4, A6; VW Golf IV, LT.

KT Code	Model	Size	Length (mm)	Weight (g)	Price
F131-34810016T	34810016T	M16H	100	270	530.-

6pc Fill / Drain plug key set

ชุดจุกเกลียวถ่ายน้ำมันเครื่อง 6 ชิ้น

Contents:

- 5061-1 6-Fill / Drain plug key 5/16"Hex - 3/8"Hex
- 5061-2 8mmSq. - 3/8" Sq.
- 5061-3 11mmSq. - 12mmHex
- 5061-4 13mmSq. - 14mmHex
- 5061-5 17mmHex - 1/2"Hex
- 5061-6 8mmHex - 10mmHex





KT Code	Model	Weight (g)	Price
F131-5061	5061	720	1,170.-

Magnetic oil drain plier

ค้ำจับน็อตถ่ายน้ำมันเครื่อง / เกียร์แบบแม่เหล็ก

- Drain old and hot engine oil, transmission fluid, and gear oil without danger.
- High-power magnet grips oil plug well.
- Pleasant oil changing work.
- Patented handle provides comfortable gripping.
- Universal application.

KT Code	Model	Weight (g)	Price
F131-61933	61933	-	690.-

64pc Oil drain repair kit

ชุดเครื่องมือซ่อมเกลียวน็อตถ่ายน้ำมันเครื่อง 64 ชิ้น

- Renew the diameter and replace a new oil drain plug.
- Four popular sizes fit nearly all applications.
- Specification: M13x1.5P, M15x1.5P, M17x1.5P, M20x1.5P
- Tap: 1 piece / size, material: SKS3
- Oil drain plug: 5 pieces / size, material: 1015
- Washer: 10 pieces / size, material: Copper





KT Code	Model	Weight (g)	Price
F131-964G1	964G1	1460	5,230.-

Fuel line pliers

คีมถอดท่อกรองเชื้อเพลิง

- Quick and easy fuel connector removal and replacement
- For use on fuel filter connectors during replacement
- Prevents fuel leakage from damaged fuel connectors
- Applications: Audi, VW, GM, Mercedes including M-class, Toyota, Fiat, Opel.





KT Code	Model	Weight (g)	Price
F131-9G0716	9G0716	335	1,770.-

Oil filter drain tool (Toyota & Lexus)

เครื่องมือถ่ายน้ำมันเครื่อง

- Provide a professional and clean work when changing oil filter.
- Available for many Toyota & Lexus (2006~) 4cyl and 8cyl vehicles.

KT Code	Model	Weight (g)	Price
F131-61923	61923	180	1,300.-

Fuel & transmission line disconnect set

ชุดสายส่งถอดน้ำมันเชื้อเพลิงและน้ำมันเกียร์

- A complete set of disconnect tools.
- With aluminum disconnect tool (1/4", 5/16", 3/8", 1/2"), two ends disconnect tool (5/16"-3/8"), long disconnect tool (1/2"), round disconnect tool (1/2"), two point disconnect tool & rubber cap x 4.









KT Code	Model	Weight (g)	Price
F131-912G3	912G3	520	2,880.-

Flexible / Moldable funnel

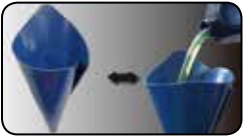
กรวยอ่อน (ถ่าย / กรองน้ำมันเครื่อง)

- Flexible funnel provides easy job for draining or refilling wide kinds of fluid and oil.
- Suitable application: engine oil, coolant, brake oil, auto transmission oil...etc.
- Easy to take anywhere, use to limited space, and easy storage.





KT Code	Model	Weight (g)	Price
F131-61926	61926	230	1,740.-

A/C, fuel line disconnect tool set

ชุด A/C ตัดการเชื่อมต่อและท่อน้ำมันเชื้อเพลิง 7 ชิ้น



- Easily disconnects air conditioning lines, quick connect fuel lines or can be used as push lock connectors on radiator and transmission lines.
- Size include: 1/4", 5/16", 3/8", 1/2", 5/8", 3/4", 7/8"

KT Code	Model	Weight (g)	Price
F131-907G10	907G10	120	570.-

Oil & fuel pipe stopper ที่อุดท่อส่งน้ำมันและเชื้อเพลิง



- Use to plug steel lines once disconnected.
- Prevents fluid leaks and contamination during service.
- Use with any automotive fluid.
- Spring loaded design installs in seconds.
- Specifications: Banjo, 3/8", 5/16", 1/2"

KT Code	Model	Weight (g)	Price
F131-904G12	904G12	157	1,290.-

Oxygen sensor socket ลูกบ็อกซ์สำหรับถอดใส่ Oxygen Sensor

- Applicable: FORD, TOYOTA, NISSAN, BENZ, BMW and most of European cars, also GM vehicles.
- Flare nut for vacuum switch & oxygen sensor service on the computer-controlled engines.
- Features: 3/8" of the double square DR. 7/8"(22mm) 12 point & 22mm 6 point.

KT Code	Model	Weight (g)	Price
F131-9G1403	9G1403	181	770.-

Universal steel line stopper ที่อุดท่อส่งน้ำมัน

- Suitable for clamping and sealing steel line on braking system, cooling system, fuel line, A/C line etc.
- Provides an effective seal to steel lines when disconnected.
- Prevents fluid loss and contamination in the work area.
- 5/16", 3/8", 1/2" and banjo(10.4mm&18mm)



KT Code	Model	Weight (g)	Price
F131-9G4301	9G4301	205	1,920.-

Oxygen sensor rethread tool ตัวล้างเกลียว Oxygen sensor

- Cleans threads in oxygen sensor holes.
- Use with 3/4" hex socket or 3/8" square drive.
- M18x1.5 also works on M18x1.5 spark plug threads.



KT Code	Model	Weight (g)	Price
F131-63007	63007	90	480.-

7pc Sensor & sending unit socket set ชุดลูกบ็อกซ์สำหรับถอดใส่ Oxygen Sensor 7 ชิ้น

- Designed for removing oxygen sensor.
- Content:**
- 01-22mm (7/8") Heated oxygen sensor socket (1/2" DR. x 7/8" x 50mmL)
- 02-22mm (7/8") Low profile offset socket (3/8" DR. x 7/8" x 30mmL)
- 03-22mm (7/8") Oxygen sensor socket (3/8" DR.x 7/8"x 6pt.x 80mmL)
- 04-22mm (7/8") Universal vacuum Pvs. Tvs valve & oxygen sensor socket (3/8" DR.x 7/8"x 6pt.x 90mmL)
- 05-1" & 1-1/16" Oil pressure sending socket (3/8" DR.x 1"x 1-1/16"x 74mmL)
- 06-1-3/16" Oil pressure sending socket (1/2" DR.x 29mm x 6pt. x 90mmL)

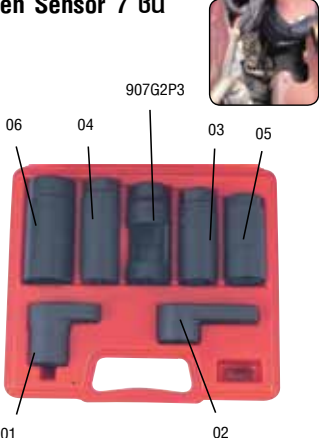

KT Code	Model	Weight (g)	Price
F131-907G2	907vG2	2140	3,130.-

Crank seal remover & installer kit ชุดเครื่องมือถอดและใส่ซีลข้อเหวี่ยง

- Allows the crank seal to be replaced without dismantling the crank case.
- Universal use covering a wide range of cars with oil seals between 27mm and 58mm in diameter.
- Use the existing bolt in the vehicle for installation.
- Screw-type adapter to t the centering.
- The blue seal adapters are made of aluminum to prevent the damage of crank.

Note:
Some cam seals have screws to prevent remove. Do not attempt to use this tool by power.







KT Code	Model	Weight (g)	Price
F131-920G1	920G1	1750	6,240.-

เครื่องยนต์

3pc Seal puller

ชุดเครื่องมือจัดตั้งซิลยาง โอริง 3 ชิ้น

- Quickly and easily remove O-Ring or grease and oil seal.
- Special angle on the tool head provides a better work than traditional seal pullers.
- 3 different lengths and tips fit nearly all seal applications.
- Simple insert the tool tips, press and pull.
- Length: 165, 117, 150mm

KT Code	Model	Weight (g)	Price
F131-903G13	903G13	200	1,420.-

4pc Hook & pick set

ชุดเครื่องมือถอดยางโอริง 4 ชิ้น

Contents:

- 904U4P1 1-Full hook
- 904U4P2 1-90° hook
- 904U4P3 1-Angel hook
- 904U4P4 1-Straight pick





KT Code	Model	Weight (g)	Price
F131-904U4	904U4	309	700.-

Crankshaft & camshaft seal remover and installer set

ชุดเครื่องมือช่วยนำศูนย์ใส่ซีล

- Ideal for both crankshaft and camshaft seal.
- Quick and easy work for both removal and installation work.
- Provided with 2 seal removers with different length and angle fits wide applications.
- Master kit includes wide size seal installers.
- Angled blade seal remover is ideal for removing seals in limited space.

KT Code	Model	Weight (g)	Price
F131-927G1	927G1	-	12,780.-

5pc Mini pick and hook set

ชุดเครื่องมือขนาดเล็ก ถอดยางโอริง 5 ชิ้น

- Miniature pick set.
- Removes O-rings in line connections and inside compressors.
- Aluminum handles with 4 stainless tools:
 - 1.awl end 3.45° bent tip
 - 2.hook end 4.90° bent tip





KT Code	Model	Weight (g)	Price
F131-905G6	905G6	44	600.-

Seal puller

เครื่องมือจัดซิลน้ำมันและซิลจารบี

- Use to remove oil and grease seals.
- Two different size tips enables this tool to accommodate most applications.





KT Code	Model	Weight (g)	Price
F131-9G0113	9G0113	375	620.-

Engine lift chain

โซยกเครื่องยนต์

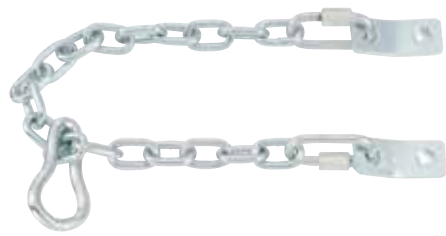
- For removal of car and light commercial vehicle engines.
- Unique self balancing and securing link lock feature, ensures safe and non-slip lifting.
- Never exceed the maximum load of 450 kg.
- Do not attach ends more than 510mm (20") apart.



KT Code	Model	Weight (g)	Price
F131-9G1511	9G1511	1080	1,240.-



➤ **Aluminum R12, R22, R134a Auto A/C manifold gauge set (with 60" hose 1/4" SAE and 2 couplers)**
ชุดเกจชาร์จน้ำยาแอร์ 134a พร้อมสายชาร์จ+หัวข้อต่อคอปเปอร์

- R-12 , R22 , R134a sight glass manifold with three 60" 1/4" SAE color-coded hoses and 2 couplers.
- With sight glasses.
- High pressure: 0-500 psi
0-3400 Kpa
- Low pressure: 0-250 psi
0-1700 Kpa
- Vacuum: 0-76 in/Hg



KT Code	Model	Weight (g)	Price
F131-9G4102	9G4102	1885	9,690.-

➤ **R-134a Adjustable quick coupler set**
ชุดข้อต่อคอปเปอร์ น้ำยา 134a รุ่นปรับเร็ว

- Inclosed the high side and low side coupler.
- The valve core puller is adjustable to fit the different valve core.



KT Code	Model	Weight (g)	Price
F131-9G4125	9G4125	400	2,220.-

➤ **R-134a Quick coupler set**
ชุดข้อต่อคอปเปอร์ น้ำยา 134a

- Inclosed the high side and low side coupler.
- Straight design suitable for conned space.



KT Code	Model	Weight (g)	Price
F131-9G4123	9G4123	190	1,570.-

➤ **12 Volt UV detection light**
ไฟฉายตรวจเช็ครอยรั่วระบบ UV ขนาด 12V

- For air condition leakage check.
- High intensity 12 volt UV lamp.
- Long cord for easy access .
- Detects all dyes.
- UV Safety Glasses Included.



KT Code	Model	Weight (g)	Price
F131-902G10	902G10	520	4,410.-





ประเภท

Bulbs pliers

คีมหนีบทลอดไฟ

- Special pliers for mounting and dismounting wedge base bulbs.
- Use for most of the car.

KT Code	Model	Weight (g)	Price
F131-9G0302	9G0302	42	650.-

Battery holder

ค้ำจับแบตเตอรี่

- Self locking design with rubber grip pads provide a secure grip on batteries 4-1/2" to 7" width.
- Suitable for top and side terminal batteries.
- Allow one handed lifting of battery in awkward location.
- Heavy duty zinc-plated steel construction for long life.





KT Code	Model	Weight (g)	Price
F131-9C2005	9C2005	541	770.-

Battery terminal & wiper pick-up tool

เครื่องมือดึงขั้วแบตเตอรี่ และที่ปัดน้ำฝน

- To work for battery terminals and windshield wipers etc.
- The tight terminals will be lifted off without damage to the battery case or posts because the sharp jaws are able to engage either below or on the sides of terminals.
- The center screw swivel also makes this puller very effective on the alternator bearings.



KT Code	Model	Weight (g)	Price
F131-9C2001	9C2001	320	1,190.-

Auto memory saving kit

เครื่องมือเก็บข้อมูลอัตโนมัติ

- Maintains the memory of car radios, clocks and computer functions when battery is disconnected.
- Simply attach a 9-volt battery and plug into cigarette lighter.
- Will retain settings up to 4 hours.
- Will not power any lights or other accessories.







KT Code	Model	Weight (g)	Price
F131-9C2008	9C2008	40	590.-

Battery brush

เครื่องมือดึงลูกปืน และขั้วแบตเตอรี่

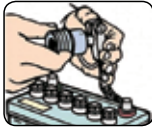
- Designed for cleaning the battery terminals.
- There are two sides for using.

KT Code	Model	Weight (g)	Price
F131-9U3002	9U3002	81	350.-

Battery hydrometer tester

เครื่องวัดความถ่วงจำเพาะน้ำกรดแบตเตอรี่

- Avoid dead battery and thus help to extend battery life.
- Test battery life - hot or cold, and thus help to prevent overcharge.
- Applicable: 6,12,24 volts system.



KT Code	Model	Weight (g)	Price
F131-9G4005	9G4005	130	410.-



Car light tester
ปากกาทดสอบไฟรถยนต์



- Checks 6-24V system
- Solid brass body with a test light.
- Prod tip is covered a brass protective screw cap.
- 850mm cable with an alligator clip on the end.



KT Code	Model	Weight (g)	Price
F131-88422	88422	36	380.-

Cordless circuit tester
เครื่องมือทดสอบกระแสไฟ แบบไร้สาย

- Detects from 3 to 28 volts.
- Safe with ECMs, sensors, transducers, airbags, etc..
- No ground wire or clip required.
- Replaceable long-life alkaline batteries included.

KT Code	Model	Weight (g)	Price
F131-88425	88425	63	890.-

Car light tester
ปากกาทดสอบไฟรถยนต์

- Checks 6-24V system
- Solid brass body with a test light.
- Prod tip is covered a brass protective screw cap.
- 850mm cable with an alligator clip on the end.



KT Code	Model	Weight (g)	Price
F131-88423	88423	79	430.-

Circuit tester
เครื่องมือทดสอบวงจรไฟฟ้ารถยนต์

- Checks 6-12-24V
- 48-in cable with insulated alligator clip.
- Tough plastic handle lights up if circuit is good.



KT Code	Model	Weight (g)	Price
F131-88432	88432	93	660.-

Auto battery and charging system analyzer
ชุดเครื่องมือทดสอบและชาร์จแบตเตอรี่



- Checks 12 volt system
- Auto battery analyzer checks batteries, regulators and alternators.
- With LED indicator that helps pinpoint problems for fast troubleshooting.



KT Code	Model	Weight (g)	Price
F131-88424	88424	45	470.-

Circuit tester for general & hybrid car
เครื่องมือทดสอบวงจรไฟฟ้ารถยนต์ สำหรับรถยนต์ทั่วไปและไฮบริด

- Compatible with current 12V system plus newer 42V system.
- Safe for low current circuits since tester only draws 3 milliamps at 12V.
- Automatic voltage identification with blue for 12V and red for 42V systems.
- Two super-bright LED's for visibility under all conditions.
- New crystal-clear handle provides 360° visibility, even in bright light.

KT Code	Model	Weight (g)	Price
F131-88433	88433	220	1,180.-



สเปคไฟฟ้า

Multi-functional auto circuit tester with LCD display

เครื่องมือทดสอบวงจรอัตโนมัติจอแสดงผลพร้อมจอ LCD

- Checks from 6V to 24V system with LCD indicator and LED illumination.
- Four modes can be selected by depressing the mode button and cycling through each one.
- Voltage meter
- Locate missing cylinders.
- Measuring rotational speed (Measuring the frequency of the high-tension ignition pulses).
- Peak Detection
- Include a Cigarette lighter adapter, a Hook-up clip, and extension 20ft lead.
- Extension Probe (85mm) included.
- Instruction manual included.

KT Code	Model	Weight (g)	Price
F131-88444	88444	1100	6,250.-

Ratchet terminal tool kit

ชุดเครื่องมือตัดขั้วแบตเตอรี่

- 1pc Terminal pliers.
- 4pc Die nests.
- 1pc Wire stripper.
- 1pc Hex key wrench.
- Crimps insulation, non-insulation & open barrel terminals.
- Built-in ratchet with safety release assures uniform crimp every time.
- It releases and opens automatically when crimping is done.
- Applicable: Insulated Terminal (0.5-1.0 / 1.5-2.5 / 4.0-6.0 mm²)
Non-Insulated Terminal (1 / 2 / 4 / 6-10 mm²)
Open Barrel Non-Insulated Terminal (0.5-1.0 / 1.5-2.5 / 4.0-6.0 mm²)
Cord-End Insulated Terminal (0.5 / 0.75 / 1.0 / 1.5 / 2.5 / 4.0 mm²)

KT Code	Model	Weight (g)	Price
F131-68013	68013	-	3,890.-

Multi-purpose connector set

ชุดสายไฟเชื่อมต่อวงจรไฟรถยนต์

- When checking the parts, it could connect the back of terminal directly, would not to damage the circuit or cut the electric wires, reduce the circuit rust and avoid adding impedance.
- Apply to any Automotive Multi-meter, the extended line of probe for oscilloscope. More convenient connection and checking rapidly.
- Variable Resister can simulate the pretend signal of coolant temperature sensor, throttle valve sensor and send the pretend signal to computer.
- Equip 2 sets LED light. It can supervise hall effect, photoelectric signal, nozzle, electromagnetic valve, electromagnetic valve of transmission shift gear...and control signals.
- SRS Connector can simulate airbag and routed contracting device of safety belt to avoid accident or miss-judgment

KT Code	Model	Weight (g)	Price
F131-990C1	990C1	2850	12,110.-

Stripper pliers

คีมปอกสายไฟ

Two functions:
A cutter & a stripper for electrical cables of 0.2mm² to 3.5mm² in diameter.

KT Code	Model	Weight (g)	Price
F131-6804	6804	220	1,260.-

2pc Insulator pierce-through clip

ชุดเครื่องมือเกี่ยวและเจาะฉนวนสายไฟ

- Applicative wire diameter: Ø1.5 ~ Ø4.5
- Voltage range : 0V ~ 30V
- Current load : Max. 5A

KT Code	Model	Weight (g)	Price
F131-902C1	902C1	-	1,670.-

Multi-purpose crimping tool

คีมปอกสายไฟอเนกประสงค์

Function:

- Wire cutter
- Crimps insulated terminals
- Bolt cutter
- Crimps non-insulated terminals (open barrel)
- Wire stripper

KT Code	Model	Weight (g)	Price
F131-6806	6806	293	1,250.-



6pc Brake spanner set ชุดประแจถอดน็อตโล่ลมเบรก 6 ชิ้น

Contents:

- 6-Brake spanner
- 6080610 1/4"Sq. - 10mmSq.
- 6080608 1/4"Sq. - 5/16"OE
- 6080810 8mmHex - 10mmHex
- 6080911 9mmHex - 11mmHex
- 6080607 1/4"Hex - 7mmHex
- 6081109 7/16"OE - 11/32"Sq.



KT Code	Model	Weight (g)	Price
F131-50612	50612	593	1,020.-

Brake spring pliers คีมถอดและใส่สปริงก้ามเบรก

- Designed by professional mechanics to remove and replace springs.
- Thin narrow points with "Straight-In-Line" pull on spring.
- Includes special socket for application on all hydraulic brakes.



KT Code	Model	Weight (g)	Price
F131-9B0102	9B0102	410	680.-

Brake spanner ประแจขันหัวโล่ลม



KT Code	Model	l mm	Application	Weight (g)	Price
F131-6080607	6080607	175	1/4"Hex. - 7mmHex.	84	250.-
F131-6080608	6080608	175	1/4"Sq. - 5/16"OE.	84	250.-
F131-6080610	6080610	175	1/4"Sq. - 10mmSq.	82	250.-
F131-6080810	6080810	175	8mmHex. - 10mmHex.	82	250.-
F131-6080911	6080911	175	9mmHex. - 11mmHex.	100	250.-
F131-6081011	6081011	175	10mmOE. - 11mmOE.	92	280.-
F131-6081109	6081109	175	7/16"OE. - 11/32"Sq.	100	250.-
F131-6081113	6081113	175	11mmOE. - 13mmOE.	108	270.-
F131-6081114	6081114	175	7/16"OE. - 9/16"OE.	102	250.-

Handbrake cable spring pliers คีมต่างสปริงสายเบรกมือ

- For compression of the retaining spring on the handbrake cable.
- This tool allows quick and problem-free removal and installation of the handbrake cable.
- Application: VW, AUDI, BMW, CITROEN, NISSAN, PEUGEOT, RENAULT, ROVER, SEAT, etc.

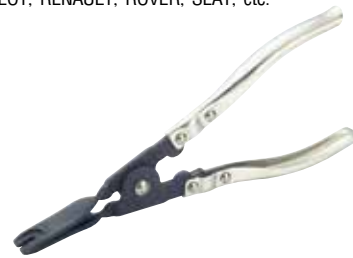

KT Code	Model	Weight (g)	Price
F131-9B0104	9B0104	230	1,330.-

Drum brake spring pliers คีมถอดและใส่สปริงก้ามเบรก

- One end hooks on the spring, the floating cap with hooks grips.
- On the lining fastened to the brake shoe.
- Use for two brake return spring system.
- Can use for most of the commercial and industrial vehicles.



KT Code	Model	Weight (g)	Price
F131-9B0101	9B0101	500	1,280.-

Drum brake spring pliers คีมถอดและใส่สปริงก้ามเบรก

- Designed to remove the brake return spring. One end grips on the brake lining and the other hooks on the spring.



KT Code	Model	Weight (g)	Price
F131-9B0105	9B0105	280	1,130.-





เบรคและเพ็ชร์

» Brake shoe spreader pliers

คีมถ่างฟีกเบรค

Time saving tool significantly reducing the time it takes to remove and install brake wheel cylinders and/or rubber boot.

KT Code	Model	Weight (g)	Price
F131-9B0106	9B0106	730	3,370.-

» Headlight adjusting and brake spring hook

ตะขอกเกี่ยวสปริงคัมเบรค

- This tool made from heat-treated alloy steel is especially designed for removing and installing hard-to-reach headlight adjusting and brake springs.







KT Code	Model	Weight (g)	Price
F131-9B0304	9B0304	75	530.-

» Brake spring washer pliers

คีมกดฟากครอบสปริงคัมเบรค

- Universal application for nearly all drum brakes.
- Special neck angle provides easy removal and installation of brake spring washer.
- Length:180.5mm.
- Heat treatment:HRC43°~46°
- Max Angle:50°







KT Code	Model	Weight (g)	Price
F131-9B0107	9B0107	250	2,010.-

» Retainer spring compressor

ค้ำกดฟากครอบสปริงคัมเบรค

- Allow fast & easy removal & replacement of brake shoe hold-down springs.





KT Code	Model	Weight (g)	Price
F131-9T0202	9T0202	150	630.-

» Brake spring tool

เครื่องมือถอดสปริงเบรค

- Universal application of both removal and installation for nearly all drum brakes.
- Wide angle application.
- Length:310mm.
- Heat treatment:HRC42°~45°





KT Code	Model	Weight (g)	Price
F131-9B0108	9B0108	375	1,650.-

» Retainer spring tool

ค้ำใส่สปริงคัมเบรคค่าง

- For removal and installation of retaining springs on such drum brakes where the brake pads are not fixed onto the anchor plate.
- Therefore the retaining spring will be inserted into the hook head of the tool and will be tightened by winding the handle.
- The installation happens by pulling the retaining spring with the tool into the correct position.

KT Code	Model	Weight (g)	Price
F131-9T0203	9T0203	101	360.-



8pc Manual brake gauge set

ชุดแผ่นวัดความหนาผ้าดิสเบรค 8 ชิ้น

- The brake gauge tool is designed to give customers an accurate measurement of how much brake lining is left without guess work.
- Most state agencies require that the customer be notified of how much brake lining is left in order to suggest that the lining should be replaced.
- The technician must refer to the OEM manufacturer specifications to determine if the lining is worn below minimum specifications.
- Size including:
 Red (Bad): 2mm (0.0787") ; 3mm (0.1181")
 Yellow (Dangerous): 4mm (0.1575") ;
 5mm (0.1969") ; 6mm (0.2362")
 Blue (Good): 8mm (0.3150") ;
 10mm (0.3937") ; 12mm (0.4724")



KT Code	Model	Weight (g)	Price
F131-908B2	908B2	250	1,260.-

Brake fluid tester

เครื่องวัดความชื้นน้ำมันเบรค

- To check the quality of brake fluid.
- 5 LED to indicate percentage of water in the brake fluid.
- LED display:
 Green: Battery OK/NO water is detected.
 Green/Yellow: Less than 1% of water.
 Green/Yellow/Yellow: Approx 2% of water.
 Green/Yellow/Yellow/Red: Approx 3% of water.
 Green/Yellow/Yellow/Red/Red: At least 4% of water.



KT Code	Model	Weight (g)	Price
F131-88502	88502	70	1,710.-

Brake shoe adjustor tool

เครื่องมือปรับตั้งครีမ်เบรค

- Can be used for most of cars.
- Make adjusting easy even for strong springs.



KT Code	Model	Weight (g)	Price
9B1701	9B1701	190	370.-

Disc brake adjuster

ตัวกดลูกสูบดิสเบรค

Fits in brake caliper to push back pistons for new brake pads installation.



KT Code	Model	Weight (g)	Price
F131-62901	62901	1100	1,880.-

Gauge for brake disc depth & tire tread

เครื่องมือวัดความหนาจานดิสเบรคและความลึกดอกยาง

- Handy, easy to use.
- Special device to fix the value you obtain while measuring the thickness of brake disc.
- Brake disc measure range: 0 ~ 60mm.
- Measure tyre depth.
- Aluminum made.



KT Code	Model	Weight (g)	Price
F131-9T0106	9T0106	250	1,040.-

Disc brake pad spreader

ตัวกดลูกสูบดิสเบรค

- Designed for quick and easy changing of disc brake pads.
- Spreader will compress inner pad and reset piston for easy pad replacement in heavy duty construction.



KT Code	Model	Weight (g)	Price
F131-9B0401	9B0401	245	510.-



7pc Brake caliper piston tools set ชุดเครื่องมือกดลูกสูบดิสเบรคแบบเกลียว 7 ชิ้น

- Kit comprises main body, screw assembly, special locating plate and 5 adaptors covering wind-back.
- Applicable: VW, AUDI, FORD, PEUGEOT, ROVER, NISSAN, SUBARU, HONDA, BMW, MITSUBISHI, TOYOTA, JAGUAR, MERCEDES, MAZDA.

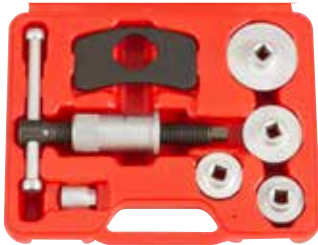

KT Code	Model	Weight (g)	Price
F131-658	658	1360	3,280.-

Brake caliper tool ชุดเครื่องมือกดลูกสูบดิสเบรคแบบเกลียว

- For rewinding the piston in all collets type disc brake calipers with built-in parking mechanism.
- Essential for fast and easy pad replacement and caliper servicing.
- Suitable for: FORD, HONDA, JAGUAR, MAZDA, MITSUBISHI, NISSAN, ROVER, SUBARU, TOYOTA, with ABS.



KT Code	Model	Weight (g)	Price
F131-65803	65803	700	1,280.-

13pc Disc brake park caliper tools set ชุดเครื่องมือกดลูกสูบเบรค 13 ชิ้น

- For rotating pistons back into the caliper to provide clearance for new pads. Include 11 adaptors (available individually) for use in both 2 and 4-wheel rear disc brake assemblies of most domestic and import cars. The tool may be used "on" and "off" the car.
- Suitable for: MERCEDES, BMW, VW, GM, AUDI, FORD, HONDA, SUBARU, MAZDA, NISSAN, MITSUBISHI, TOYOTA, ROVER, 4WD, OPEL, RENAULT.

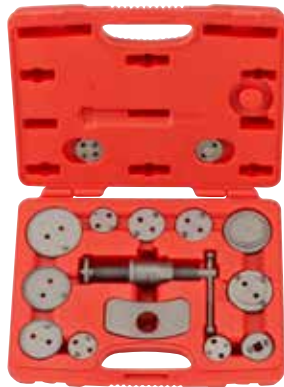

KT Code	Model	Weight (g)	Price
F131-65802	65802	2000	3,520.-

16pc Air powered brake caliper wind back tool set ชุดเครื่องมือกดลูกสูบดิสเบรคแบบใช้ลมช่วย 16 ชิ้น

- Air Pressure: The range of normal using pressure is 5 ~ 8 kg/m²; maximal using pressure is 14 kg/m².
- Applicable: Citroen, AUDI, FIAT, FORD, ISUZU, HONDA, JAGUAR, BMW, NISSAN, MITSUBISHI, VW, SAAB, MAZDA, TOYOTA...etc.



KT Code	Model	Weight (g)	Price
F131-65815	65815	3140	6,330.-

18pc Universal caliper wind back kit ชุดเครื่องมือกดลูกสูบดิสเบรค ชนิดลูกสูบแบบเกลียว 18 ชิ้น

- Two bodies with positive thread and negative thread for different vehicles.
- With one plate and fifteen adaptors to fit most of the cars.
- Applicable: Citroen, AUDI, FIAT, FORD, ISUZU, HONDA, JAGUAR, BMW, NISSAN, MITSUBISHI, VW, SAAB, MAZDA, TOYOTA...etc.

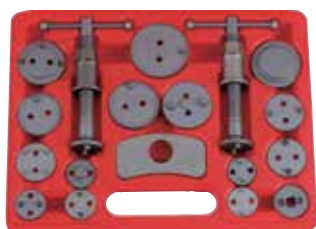

KT Code	Model	Weight (g)	Price
F131-65805	65805	2480	3,810.-

Foldable cross-handle socket wrench กาบหกขันท่อน็อตล้อ

Socket size: 17mm; 19mm; 21mm; 1/2" square

พับได้



KT Code	Model	l (mm)	Weight (g)	Price
F131-681400	681400	400 (16")	1490	1,470.-
F131-681500	681500	500 (20")	1760	1,610.-

เบรคและเกียร์

Assembly wheel nut wrench กากบาทถอดตามได้

- 17mm; 19mm; 13/16"; 1/2"DR. (300mmL)
- Chrome vanadium alloy steel
- For most car wheel nuts in metric
- Polished, chrome plated



KT Code	Model	Weight (g)	Price
F131-681A300	681A300	1110	1,770.-

Wheel balancing weight tool คีมสำหรับงานถ่วงน้ำหนักล้อ



- Easily removes and replaces wheel weights, as well as cutting and crimping.
- Made of heat-strengthened steel. Included comfortable vinyl handle grips.
- With self-open function spring on the handle for easier operation.



KT Code	Model	l (mm)	Weight (g)	Price
F131-6821	6821	245	420	1,250.-

Wheel nut wrench กากบาทถอดตามได้



- 17; 19; 21; 22 mm with 1/2"DR. Adapter (400mmL)
- Chrome vanadium alloy steel
- For most car wheel nuts in metric
- Polished, chrome plated

KT Code	Model	Weight (g)	Price
F131-681B400	681B400	1550	960.-

Tyre lever เหล็กจัดยาง

* 750...B ชนิดปลายงอ

KT Code	Model	l (mm)	Weight (g)	Price
F131-750200	750200	200	162	430.-
F131-750300	750300	300	370	510.-
F131-750380	750380	380	556	600.-
* F131-750380B	750380B	380	382	680.-
F131-750500	750500	500	732	1,020.-
* F131-750525B	750525B	525	800	1,390.-
F131-750650	750650	650	1160	1,280.-
* F131-750650B	750650B	650	1160	1,250.-

Reverse action wheel stud thread restorer kit ชุดล้างเกลียวน็อตล้อ

- Unique design allows the two halves of the thread restorer to be fitted on the good thread and wound back over the damaged thread, normally at the end of the stud.
- Traditional thread restorers rely on luck for the restored and undamaged threads to align.
- Three sizes of product a set of capacity: M12 X 1.25 ; M12 X 1.5 ; M14 X 1.5



KT Code	Model	Weight (g)	Price
F131-906T5	906T5	260	1,810.-

Wheel balancing weight tool คีมสำหรับงานถ่วงน้ำหนักล้อ หัวค้อนพลาสติก

- Use to install, remove, trim and tighten clip on wheel weights.
- Includes plastic hammer head for protection of specially coated wheel weights.





KT Code	Model	Weight (g)	Price
F131-9T0302	9T0302	500	1,570.-



Snap in tire valve installer

เหล็กดิ่งจูปเลส

Steel constructed tool with deep threaded head for positive sealing of all snap-in type passenger car tire valve stems.



9B0301

9B0302

KT Code	Model	Weight (g)	Price
F131-9B0301	9B0301	350	740.-
F131-9B0302	9B0302	356	710.-

4pc T-handle disclosed tire repair tool set

ชุดเครื่องมือปะยาง แบบแทงใส่ไหม

For steel belted radial tire. T-handle disclosed tire repair tool is for inserting plugging material typically in the form of rubber coated strands, into a tire puncture. The plugging material is threaded into the open eye of a needle forming a part of the tool and inserted into the puncture. The inserting motion is limited by a stop free to rotate on the needle's shank so that the ends of the strand are not drawn into the puncture and the stop also limits the withdrawal of the needle.



KT Code	Model	Weight (g)	Price
F131-904T4	904T4	354	1,720.-

Dual check

หัวเติมลม

9T0402

9T0403

KT Code	Model	Length	Weight (g)	Price
F131-9T0402	9T0402	6	75	310.-
F131-9T0403	9T0403	12	140	440.-

Roller stitcher

ลูกกลิ้งยาง

- Wood handle for light and portable.
- Bearing inside for easier using.



KT Code	Model	Weight (g)	Price
F131-9T0407	9T0407	123	530.-

2pc Tire valve torque driver set

ไขควงขันวาล์วจูปเลส 2 ชิ้น

- Tools have internal torque limiting mechanism to prevent over-torquing of tire pressure monitoring system valve cores.
- A must for the tire pressure monitoring system valves to maintain proper tire pressure.
- Each tool is set for a specific maximum torque:
Red-25 Ncm (2.2 IN. LB)
Black-45 Ncm (4 IN. LB)



9U3201

9U3202

KT Code	Model	Weight (g)	Price
F131-902U3	902U3	120	1,460.-

4WD Front wheel bearing tool

ชุดเครื่องมือถอดและใส่ลูกปืนล้อหน้า รถเก๋ง/กระบะ

- 21pc Bearing cup size:
38, 50, 55, 59, 63.5, 66.5, 70.5, 71.5, 73, 73.5, 74.5, 76, 77.5, 81.5, 83.5, 86, 86, 88.5, 91, 102, 102mm
- 1pc Nut
- 1pc Screw
- 1pc Washer



KT Code	Model	Weight (g)	Price
F131-924T1	924T1	10.5	11,580.-





ใบสแตนเลส

10pc Bearing race and seal driver set

ชุดเครื่องมือตอกใส่ตัวลูกปืนและบูชซีลยาง

Makes it easier to insert wheel bearing race and seals without damage to race and axle housing. The set includes 9 disc sizes to fit most standard wheel bearing. Turn discs over to drive seals.

KT Code	Model	Weight (g)	Price
F131-66603	66603	1780	3,560.-

Ball joint separator

ตัวถอดลูกหมาก

- For splitting track-rod ends, anti-roll bar mountings, ball joints, etc.
- Jaw open: 20mm





KT Code	Model	Weight (g)	Price
F131-62802	62802	1050	940.-

Slide hammer puller set

ชุดเหล็กตอกเพลาควมล้อและชุดตอกลูกปืนแบบกระตุก

Slide hammer puller set has several pulling attachments to give the user various methods for pulling, maintenance and repair applications: the slide hammer exerts force when needed.



KT Code	Model	Weight (g)	Price
F131-664A	664A	950	9,360.-

Ball joint separator

ตัวถอดลูกหมาก

- For splitting track-rod ends, anti-roll bar mountings, ball joints, etc.
- Jaw open: 20mm





KT Code	Model	Weight (g)	Price
F131-62803	62803	1060	1,740.-

Ball joint separator

ตัวถอดลูกหมาก

- Heat treated drop forged steel body & bolt for long rough usage.
- Spread ball joints easily where space prevents use of direct action method.
- Jaws open: 19mm





KT Code	Model	Weight (g)	Price
F131-62801	62801	1220	1,810.-

Ball joint separator

ตัวถอดลูกหมาก

- Special design 2-stage operating suits most cars and light trucks ball joints in steering & suspension.
- Offset lever permits maximum jaw opening in 30mm & 56mm.
- Jaw open: 22mm



KT Code	Model	Weight (g)	Price
F131-62804	62804	1218	2,230.-



ใบสเปค: เกียร์

Ball Joint extractor

ตัวถอดลูกหมาก

- For splitting track-rod ends, anti-roll bar mountings, wheel-hub ball joints, etc.
- Jaw open: 22mm
- 2-Stage, 50-80mm.



KT Code	Model	Weight (g)	Price
F131-62806	62806	1620	3,100.-

Ball joint extractor

ตัวถอดลูกหมาก (แบบดุด)

- For splitting track-rod ends, anti-roll bar mountings, ball joints, etc., especially in small space conditions.
- 6280728 is for Audi A4, A6, A8, VW Passat and Mercedes W203 etc.



KT Code	Model	Jaws Open mm	Jaws Deep mm	Weight (g)	Price
F131-6280728	6280728	28	25	800	3,540.-

Universal ball joint extractor

ตัวถอดลูกหมากปีกนก

- For splitting track-rod ends, anti-roll bar mountings, ball joints, etc.



KT Code	Model	Size (mm)	Weight (g)	Price
F131-6281518	6281518	18	695	2,000.-
F131-6281522	6281522	22	715	1,850.-
F131-6281532	6281532	32	2360	4,450.-
F131-6281545	6281545	45	2550	4,550.-

Universal ball joint puller

ตัวถอดลูกหมาก (แบบดุด)

Special steel for removing the ball pivots on steering arms, steering tie rocks, steering knuckles etc.



KT Code	Model	Jawopen	Weight (g)	Price
F131-6280817	6280817	17mm	1020	1,870.-
F131-6280820	6280820	20mm	1170	1,940.-

Universal ball joint separator

ตัวถอดลูกหมากแบริ่ง ตัวนอก

- Special steel for removing the ball pivots on steering arms, steering tie rocks, steering knuckles, etc.
- Jaws open: 30mm



KT Code	Model	Weight (g)	Price
F131-62809	62809	2900	7,070.-

Four-way ball joint remover tool

ตัวถอดลูกหมาก (4 ใน 1) รุ่นงานหนัก

- Heat treated drop forged steel body & bolt for long rough usage.
- Spread ball joints easily where space prevents use of direct action method.

Total length: 165mm
Opening angle: 24mm ~ 45mm
Jaw opening: 22mm
Body material: SCM440



KT Code	Model	Weight (g)	Price
F131-62819	62819	1600	3,380.-



Tie rod end & pitman arm puller for compact cars
ตัวถอดลูกหมากคันชัก/ขาโก่ง สำหรับรถรุ่นเล็ก

- For the safe easy removal of pitman arm assembly from compact automobiles.
- Forged, heat-treated yoke with extra heavy center screw
- Opening: 1-1/16"(27mm)
- Pull: 1-3/4"(45mm)



KT Code	Model	Weight (g)	Price
F131-62811	62811	445	790.-

Outer tie rod remover
ตัวถอดลูกหมากคันส่ง (แบริคตัวนอก)



- Two adjustable jaws special designed for removing outer tie rods of most models.
- Works on imports and domestics: front or rear wheel drives and castors stamped steel steering knuckles.
- Spread: 2-1/2" (64mm)
- Reach: 2-1/4" (57mm)



KT Code	Model	Weight (g)	Price
F131-62814	62814	1090	2,060.-

Tie rod end & pitman arm puller
ตัวถอดลูกหมากคันชัก/ขาโก่ง

- Redesigned heavy duty tool to be used to remove pitman arms from late model cars and light trucks
- Yoke is forged from high grade alloy steel and heat-treated.
- Opening: 1-5/16"(33mm)
- Pull: 2-1/2"(64mm)

KT Code	Model	Weight (g)	Price
F131-62812	62812	795	810.-

Universal tie rod end tool
ตัวถอดลูกหมากปีกนก

- Heat treated drop forged steel body & thrust bolt.
- Fits most cars, simply insert tool between spindle arm and tie rod, turn thrust bolt with 3/4"(19mm) socket or spanner to spread tie rod easily.
- Fork 18mm(11/16").



KT Code	Model	Weight (g)	Price
F131-62817	62817	450	730.-

Pitman arm puller
ตัวถอดลูกหมากคันชัก/ขาโก่ง

- Designed to handle the toughest Pitman arm pulling jobs on passenger cars and light trucks.
- Features special forged jaws shaped to fit the job.
- To use, simply remove the retaining nut, place the puller jaws behind the pitman arm and tighten the forcing screw.
- Mechanical power does the rest.
- Opening: 1-5/16" (33mm)
- Pull: 2-1/2" (64mm)



KT Code	Model	Weight (g)	Price
F131-62813	62813	1134	1,070.-

Front end service set
ชุดเครื่องมือถอดลูกหมาก 6 ชิ้น

- This versatile set allows for easy removal of the most popular types of pitman arms, tie rods and ball joints.
- Press type ball joint separator allows for ball joint removal without damage to boots and other parts that fork type removers may cause.

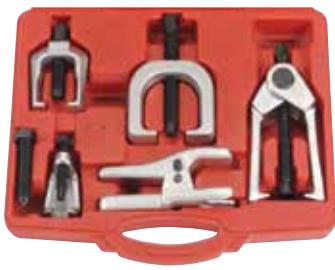

KT Code	Model	Weight (g)	Price
F131-906T3	906T3	5200	5,310.-



Ball joint extractor

ตัวถอดลูกหมากปีกนก/คันทรง

For splitting track-rod ends, anti-roll bar mountings, ball joints etc.



KT Code	Model	Open Size	Weight (g)	Price
F131-628E18	628E18	18mm	316	1,610.-
F131-628E23	628E23	23mm	533	1,830.-
F131-628E29	628E29	29mm	880	3,170.-
F131-628E40	628E40	40mm	1550	3,740.-
F131-628E46	628E46	46mm	1750	3,870.-

Ball joint separator

ข้อต่อลูกหมาก

- Tempered drop forged steel one piece construction for long & rough usage.
- Replacing worn out ball joints easily with a hammer striking.
- 628300 also can separate shock absorber links.
- 628400 also can remove CV drive shafts on FWD vehicles
- Material:SCM440.



KT Code	Model	Open Size	Z (mm)	Weight (g)	Price
F131-628300	628300	15/16"	300	680	690.-
F131-628400	628400	21/32"	400	950	720.-

Ball joint puller bell vibro-impact

ตัวถอดลูกหมากคันทรง/คันทรง



KT Code	Model	size mm	Weight (g)	Price
F131-62818	62818	25	1290	7,410.-
F131-6281830	6281830	30	1950	3,980.-
F131-6281832	6281832	32	2820	7,070.-
F131-6281839	6281839	39	3400	7,540.-

1/2" DR. BENZ (W163/W164) Pin wrench socket

Pin wrench socket สำหรับ BENZ

- Used for Secure the retaining ring during R&R of ball joints.
- Applicable: MERCEDES-BENZ M-CLASS (W163/W164) lower ball joint of front & rear axles.



KT Code	Model	Weight (g)	Price
F131-62820	62820	291	1,570.-

5pc Tie rod ball joint separator set

ชุดเครื่องมือถอดลูกหมาก 5 ชิ้น

Made from heat treated drop forged steel.

Contents:

- 1pc Tie rod separator Opening: 17mm (11/16")
- 1pc Ball joint separator Opening: 24mm(15/16")
- 1pc Pitman arm wedge Opening: 28mm(1-1/8")
- 1pc Handle with lock nut 8"(200mm)
- 1pc Pneumatic handle 7"(180mm)



KT Code	Model	Weight (g)	Price
F131-905T2	905T2	2000	2,450.-

Multi-purpose inner tie rod tool

ตัวถอดลูกหมากแร็ค ตัวโน

- The master tie rod tools easily replaces inner tie rod ends without removing the rack & pinion.
- Capacity: 33-42mm



KT Code	Model	Weight (g)	Price
F131-9T0801	9T0801	397	2,940.-



Coil spring compressor

ตัวกดสปริงใช้ค้อนแบบขอก๊วย

- Use tool to remove and install automotive coil springs up to 5-5/8" OD. designed to grasp a maximum 3/4" wire diameter spring.
- Compress can be used on straight or curved coil spring.
- Forged alloy steel.



KT Code	Model	Weight (g)	Price
F131-62701	62701	1416	1,500.-

Universal spring compressor

ตัวกดสปริงใช้ค้อนแบบขอก๊วย (ชุด 2 ชิ้น)

627200

- Allows the compressing of the spring at the car, so the strut can be taken out without dismantling the bearing housing.
- This is important at the front axle of VW cars and at rear axle of Ford Mondeo etc.

627320

- For use with all Macpherson.
- The spindles are equipped with contra-rotating threads which eliminate the risk of slipping round the spring.

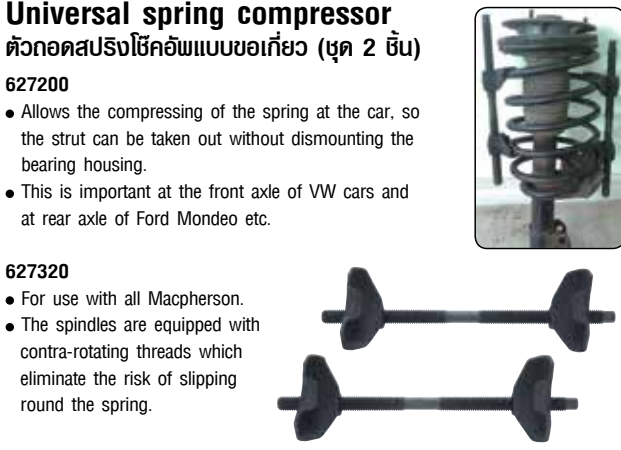

KT Code	Model	Compression length (mm)	Weight (g)	Price
F131-627200	627200	65-200	2410	4,270.-
F131-627320	627320	65-320	2880	4,520.-

Coil spring compressor

ตัวกดสปริงใช้ค้อนแบบขอก๊วย (ชุด 2 ชิ้น)

- Coil spring compressor made by forging and easy to use.
- Sold and packed in pair.

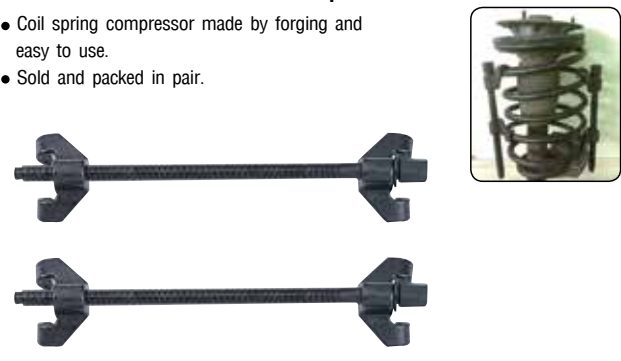

KT Code	Model	l (mm)	Weight (g)	Price
F131-627270	627270	270	1830	1,970.-
F131-627370	627370	370	2170	2,320.-

Heavy duty coil spring compressor

ชุดเครื่องมือถอดใช้สปริงงานหนัก

- Hooks engage spring which can be compressed by turning hex nut.
- Jaws capacity: 23mm ~ 280mm
- Length 280mm



KT Code	Model	Weight (g)	Price
F131-627280	627280	3200	6,420.-

Universal spring compressor

ตัวกดสปริงใช้ค้อนแบบขอก๊วย (ชุด 2 ชิ้น)

- For replacement of self leveling shock absorbers.
- Particularly for rear axles on Mercedes and Fords.
- Compression length: 85-170mm
- Hex drive situated in the centre of the spindle permitting easy use in confined spaces where other spring compressors can not be used.



KT Code	Model	Weight (g)	Price
F131-627170	627170	2350	4,240.-

Heavy duty coil spring compressor with jaws & holder

ชุดเครื่องมือถอดใช้สปริงงานหนัก

- No need extra systematic jaw installation / removal
- High security coil spring compressor with 1200kg maximum capacity per pair and adjustable safety bar for additional security
- Jaws capacity : 23 mm ~ 280 mm
- Length 280mm



KT Code	Model	Weight (g)	Price
F131-627280U	627280U	4200	9,590.-



เบรกและเกียร์

Universal strut spring compressor

ชุดเครื่องมือถอดสปริงแบบขาทำมุม

- This tool fits a wide range of struts without the inconvenience of special adaptor shoes.
- Tool compresses springs of 4" to 8" OD. with wire diameters of 7/16" to 11/16". Works both by hand or impact wrench.
- The jaws of the compressor are held in place by safety locking pins.
- Use most of spring compressor quickly and easily on the bench or on the vehicle.





KT Code	Model	Weight (g)	Price
F131-62702	62702	9350	10,130.-

CV Boot clamp pliers

คีมย้ำหัวเข็มขัด รัศยางค์บูทเพลลา (สายรัดแบบไม่มีหู)

A sturdy tool, works on earless-type clamps including those found on GM inboard CV joint.

KT Code	Model	Weight (g)	Price
F131-62519	62519	320	590.-

39pc Turnbuckle for shock absorber's top lid

ชุดข้อต่อจับแกนโช้คอัพ 39 ชิ้น

- The complete sizes for using of most kinds of cars.

Contents:

- 5pc external sockets 10.5, 12.5, 14, 14.5(14.5x5), 14.5(14.5x3)mm
- 9pc external sockets 14, 16, 17, 18, 19, 21, 22, 24, 27mm
- 9pc central sockets 4, 5.2, 6, 6.3, 7, 8, 9, 10, 12mm
- 2pc central sockets 5, 10mm
- 4pc central sockets 8, 9, 10, 11mm
- 4pc central sockets 5, 6, 7, 8mm
- 3pc central sockets 3, 3.5, 4mm
- 1pc central socket M12
- 2pc central sockets T50, T60



• Apply to : VW, AUDI, M-BENZ, AUSTIN MAESTRO, HONDA, NISSAN, SEAT, FIAT, FORD, ROVER, OPEL, PEUGEOT, RENAULT, CITROEN, TOYOTA, CHRYSLER, BMW, VOLVO.

CV Joint boot clamp pliers

คีมย้ำหัวเข็มขัด รัศยางค์บูทเพลลา (สายรัดชนิดมีหู)

For ear type clamps, fits late model GM CV joint boots, also installs PERMA-QUICK type clamps quickly and easily use for filter, cooling system and vacuum lines.







KT Code	Model	Weight (g)	Price
F131-62520	62520	380	620.-

CV Dust boot clamp installer with cutter

ตัวรัดเหล็กรัศยางค์บูทเพลลา พร้อมคัตเตอร์

- Use 1/2" socket wrench to wind and crimp by hand tool is easily disengaged from the band after the band is tightened.
- Cut off easily with built in cutting arm without any other tool.

KT Code	Model	Weight (g)	Price
F131-939T1	939T1	6250	14,090.-

CV Dust boot clamp installer with cutter

ตัวรัดเหล็กรัศยางค์บูทเพลลา พร้อมคัตเตอร์

- Use 1/2" socket wrench to wind and crimp by hand tool is easily disengaged from the band after the band is tightened.
- Cut off easily with built in cutting arm without any other tool.





KT Code	Model	Weight (g)	Price
F131-62521	62521	510	1,250.-



Air powered CV boot installation tool

เครื่องมือลมกดอย่างหุ้มเพลลา

- Innovative tool saves time, money and frustration.
- Installs flexible steering and CVJ boots without removing axle from the vehicle or the CV joint from the axle.
- No effort-wasting and no mess.
- Save labour time by up to 70% and prevent damage to CV joint.
- Composite body with simple control valve works from standard workshop air supply.
- Suitable for cars, small vans, light commercial vehicles.
- Material: Aluminum steel
- Capacity: Ø20-110mm



KT Code	Model	Weight (g)	Price
F131-9T0502	9T0502	3565	9,290.-

Oil draion tray

ถังรองถ่ายน้ำมันเครื่อง



9T3710 9T3709

KT Code	Model	Volume L	Weight (g)	Price
F131-9T3709	9T3709	5	665	1,500.-
F131-9T3710	9T3710	10	1000	1,650.-

Pneumatic brake fluid extractor / refilled kit

ที่ดูดน้ำมันเบรก + ถัง Refill 1 ลิตร

- The unit creates a powerful vacuum that is used to bleed and flush hydraulic brakes and clutches.
- Large, stable base so it won't tip, requires no special adaptors.
- Automatic refilling of the master cylinder reservoir while bleeding.
- Universal drain valve fits to most standard recycling system.
- Working Pressure 70-170 PSI / 4.9-11.9 BAR
- Air inlet: 1/4"
- Air Consumption: 5.0 CFM
- Extracting Tank Capacity: 2.0 L
- Refilling Bottle: 1.0 L



KT Code	Model	Weight (g)	Price
F131-9T3608	9T3608	2600	8,890.-

2pc Rubber ring hook tool set

ชุดตะขอเกี่ยวยางทิวท้อเอเชีย 2 ชิ้น

- Essential for safe, controlled removal of clamps attaching exhaust to manifold.
- Special design provides "LEVERAGE" required to expand the strong spring clamps.
- For Volkswagen.

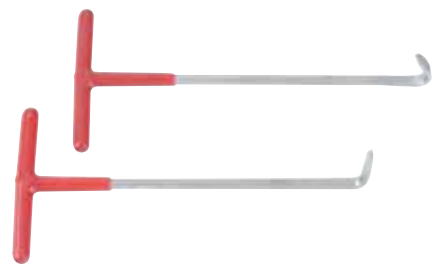

KT Code	Model	Weight (g)	Price
F131-902T1	902T1	220	660.-

Oil drain tray

ถาดกลมรองถ่ายน้ำมันเครื่อง

- Material: PE
- Dish to save the slop oil.
- Special design on rim for prevent the oil comes out.
- And the producing hole also has special design to pour out the oil.
- Molded handles and 45° spout permit easy handling and pouring.



KT Code	Model	Volume L	Weight (g)	Price
F131-9T3706	9T3706	8	540	1,230.-
F131-9T3707	9T3707	16	950	1,400.-

Replaceable oil pan separator and clean set

ชุดเครื่องมือชุดประเก็นแบบตอกและอุปกรณ์ทำความสะอาด

- Breaks gasket seals on engine sumps, transmissions or any difficult to separate gasket joints.
- The copper blade could avoid damage on gasket or oil pan connection joint surface.
- Clean up wheel tool helps use to clean all small spaces on cylinder head.



KT Code	Model	Weight (g)	Price
F131-919T1	919T1	360	2,660.-





ใบสเปค: เกียร์

Exhaust hanger removal tool

คีมถอดยางหัวท่อไอเสีย

- Easily remove exhaust rubber hanger for a wide range of applications.

KT Code	Model	Weight (g)	Price
F131-9T0316	9T0316	710	1,570.-

3pc Tailpipe expanders set

ชุดเครื่องมือขยายท่อไอเสีย 3 ชิ้น

- Heavy-duty tools flare and expand in mufflers and tailpipes. Features exist long hex bar.
- Three sizes fit all automotive applications.
- Capacity:
 - 903T3A: 1-1/8"-1-3/4" (29-44mm)
 - 903T3B: 1-1/2"-2-7/16" (38-62mm)
 - 903T3C: 2-1/8"-3-7/16" (54-87mm)



KT Code	Model	Weight (g)	Price
F131-903T3	903T3	3000	4,420.-

Magnetic adjustable camber gauge

เกจแม่เหล็กเอนกประสงค์ ตั้งศูนย์ล้อ มุมแคมเบอร์

- It has a simple leveling adjustment of +/-3°. Housed in a durable, non-magnetic casing with a magnetic head that attaches firmly to rotors or spindles.
- Time/money saving device
- Return a strut to its original camber after repair or replacement.
- Measure camber change before reinstalling alignment heads during camber kit installation.
- Check the amount of camber change before reinstalling tire and wheel assemblies on trucks receiving offset alignment bushings.



KT Code	Model	Weight (g)	Price
F131-68801	68801	500	3,520.-



11pc 10LBS Dent puller set

ชุดเครื่องมือกระตุกขุมล้อ 10LBS + ตัวช่วยดึง 11 ชิ้น

Contents:

- 1pc Pipe (Diameter 22.5mm x 590mmL)
- 1pc Pipe (Diameter 22.5mm x 200mmL)
- 1pc 2 Hole pipe (Diameter 29mm x 40mmL)
- 1pc Hammer (10lbs.)
- 1pc Plate (6mm x 170mm) / 1pc Plate (6mm x 120mm)
- 1pc Plate (6mm x 120mm) / 1pc Plate (6mm x 200mm)
- 1pc Plate (3mm x 100mm)
- 1pc Chain & hook
- 1pc Hex nut (29mm)

KT Code	Model	Weight (g)	Price
F131-665B	665B	8420	4,060.-

7pc Auto body repair tool set

ชุดค้อนเคาะตัวถังรถยนต์ (กล่อง blow Case) 7 ชิ้น

Contents:

- 62602 1-Pick & finishing hammer
- 62603 1-Light shrinking hammer
- 62604 1-Standard bumping hammer
- 68301 1-Utility dolly
- 68302 1-Curved dolly
- 68303 1-Heel dolly
- 68304 1-Toe dolly

KT Code	Model	Weight (g)	Price
F131-50713B	50713B	7300	9,150.-

10pc 12LBS Klocker set

ชุดเครื่องมือกระตุกขุมล้อ 12LBS + ตัวช่วยดึง 10 ชิ้น

For those hard to reach places on unit-sized body reconstruction, when working on fenders, rocker panels, door edges, bumper ends, aligning doors, hoods, trunks etc. hammers both ways without reversing. Solid 5/8" steel slide shaft, pipe end nose adapter is machined and plated.

KT Code	Model	Weight (kg)	Price
F131-910M1	910M1	10	5,800.-

7pc Auto body repair tool set

ชุดค้อนเคาะตัวถังรถยนต์ 7 ชิ้น

Contents:

- 62604 1-Standard bumping hammer
- 62602 1-Pick & finishing hammer
- 68305 1-Grid toe dolly
- 68306 1-Double end hand dolly
- 68302 1-Curved dolly
- 68353 1-Drip molding spoon
- 68354 1-Light dinging spoon

KT Code	Model	Weight (g)	Price
F131-50719	50719	7460	9,240.-

Air suction dent puller

เครื่องมือลมดูดคลายขุม

- With 120mm & 150mm pad
- With 3LB(1.36kgs) sliding hammer
- With brass shut off valve
- With 13" length inlet hose
- Air exhaust from the handle
- With 1/4" air plug

KT Code	Model	Weight (g)	Price
F131-905M4	905M4	3800	8,090.-

11pc Auto body repair set (interchangeable)

ชุดค้อนเคาะตัวถังรถยนต์ (ถอดเปลี่ยนหัวได้) 11 ชิ้น

- Material: Main hammer made from drop forged tool steel; all bits made from Chrome-Vanadium
- Double locking device holding tight
- Save space / weight
- Save money / time
- Create high efficiency

Warning: Form hitter hits shank has to be inserted to the hole's bottom.

KT Code	Model	Weight (g)	Price
F131-911M1	911M1	2300	3,850.-

7pc Auto body repair tool set ชุดเครื่องมือยางเคาะตัวถังรถยนต์ 7 ชิ้น

Contents:

- 1-Rubber heel dolly (size: 2-1/2" x 3" x 1-1/2")
- 1-Large rubber heel dolly (size: 5" x 3" x 1-1/2")
- 1-Rubber double end hand dolly
- 1-Rubber general purpose dolly
- 1-Rubber wedge dolly
- 1-Rubber toe dolly
- 1-Rubber drip molding spoon



KT Code	Model	Weight (kg)	Price
F131-50720	50720	11	8,850.-

Angle and flat short double spoon ข้อรองเคาะแบน ตัวแอล

- Length: 401 mm
- Width: 58mm
- Head material: 1055 medium carbon steel



KT Code	Model	Weight (g)	Price
F131-68352	68352	1787	2,270.-

Twist & shrinking hammer ค้อนเคาะตัวถัง (ปลายลิ้มโค้ง)

Specially designed hammer surface profile has a good performance of expanding and making convex on sheet board.



KT Code	Model	Weight (g)	Price
F131-62601	62601	510	1,890.-

Grid toe dolly เหล็กรองเคาะ: เข้ามุมโค้งมีปุ่ม

- To use for shrinking metal stretched by dents.
- Length: 122mm
- Width: 59mm
- Depth: 29mm
- Head material: 1055 medium carbon steel



KT Code	Model	Weight (g)	Price
F131-68305	68305	1385	1,510.-

Angle and flat double spoon ข้อรองเคาะแบน ตาขอ

- Length: 510 mm
- Width: 59mm
- Head material: 1055 medium carbon steel
- Head polished: mirror polished



KT Code	Model	Weight (g)	Price
F131-68351	68351	2425	3,030.-

Drip molding spoon ข้อรองเคาะ:

- Length: 236 mm
- Width: 49mm
- Head material: medium carbon steel



KT Code	Model	Weight (g)	Price
F131-68353	68353	1258	1,420.-

Light dinging spoon
ช้อนรองเคาะแบบ

- To ding ridges smooth and level.
- When held against ridge and struck with hammer, spreads blow over large area.
- Making smooth job and preventing damages to metal or finish.
- Length: 250 mm
- Width: 50.8 X 109mm
- Head material: medium carbon steel



KT Code	Model	Weight (g)	Price
F131-68354	68354	378	820.-

Corrosion assessment tool
บ่อนเคาะ-ตัวกึ่งแบบสองหัว

- Combines tapping hammer, blunt scraper and short lever.
- For checking bodywork and structural corrosion.
- Designed for the vehicle inspectorate.



KT Code	Model	Weight (g)	Price
F131-9M1501	9M1501	110	660.-

Short single spoon (light duty type)
ช้อนรองเคาะแบบ หน้าแคบ

- Length: 286mm
- Width: 51mm
- Head material: 1055 medium carbon steel



KT Code	Model	Weight (g)	Price
F131-68355	68355	850	1,740.-

Sheet metal bending pliers
คีมจับแผ่นโลหะปากตรง ยาว 280 มม.

- Easy to do the automobile body work



KT Code	Model	Description	Length (mm)	Weight (g)	Price
F131-9M0301	9M0301	Straight	280 (11")	650	2,140.-
F131-9M0302	9M0302	45 Degrees	280 (11")	650	2,220.-
F131-9M0303	9M0303	90 Degrees	280 (11")	800	2,410.-

Double end hand dolly
เหล็กรองเคาะ- ด้านรอง 2 ด้าน

- Length: 66mm
- Width: 61mm
- Depth: 74mm
- Head material: 1055 medium carbon steel



KT Code	Model	Weight (g)	Price
F131-68306	68306	1175	1,380.-

Welder's Flat Grip Wrench
คีมล็อคนงานเชื่อม 11 นิ้ว / 270 มม.

- Especially designed for the pipe welding.
- Length : 11" / 270mm

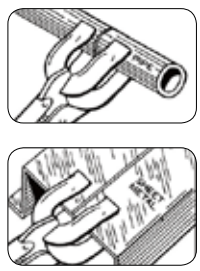
KT Code	Model	Weight (g)	Price
F131-65203	65203	620	1,260.-



» Auto body repair pull clamp
 แคมป์ดึงตัวดึงทางเดียว 5 ตัน



- Single direction action
- Capacity: 5 tons



KT Code	Model	Weight (g)	Price
F131-62501	62501	1940	2,570.-

» Twin pull hook
 ตัวดึงแคมป์ 2 ทาง 6 ตัน ขนาดโซ่ 3/8", 5/16"

- Applying for two clamps are connected by a chain and make a two sides action. (3/8" and 5/16" chain applicatory)
- Capacity: 6 tons

KT Code	Model	Weight (g)	Price
F131-62515	62515	1080	1,720.-

» Auto body repair pull clamp (two way)
 แคมป์ดึงตัวดึงสองทาง (5 ตันดึงทางขวางได้ 2 ตัน)



- Two direction action
- Cross capacity: 2 tons
- Longitudinal capacity: 5 tons

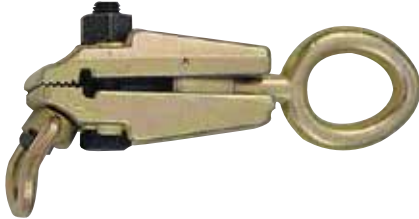

KT Code	Model	Weight (g)	Price
F131-62502	62502	2100	2,970.-

» Body jig chain connector link
 ตัวรับระยะโซ่ (ทนแรงดึงได้ 6 ตัน)

- Applying for connecting and shortening the chain. (3/8" and 5/16" chain applicatory)
- Capacity: 6 tons

KT Code	Model	Weight (g)	Price
F131-62516	62516	630	1,590.-

» Auto body repair pull clamp
 แคมป์ดึงตัวดึงทางเดียว 3 ตัน

- Single direction action
- Capacity: 3 tons



KT Code	Model	Weight (g)	Price
F131-62503	62503	2000	2,840.-

» Adjustable body file blade holder
 ตะไบปรับโค้ง ยาว 14" / 350 มม.

Application: for 14" (350mm) flexible file adjustable frame.



KT Code	Model	Weight (g)	Price
F131-65701	65701	785	1,360.-



Hydraulic bearing separator puller set ชุดงานประเภทยึด H-Type 75-105 มม.

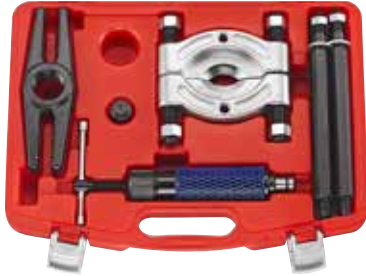

Contents:
 1pc Hydraulic ram (SCM415 Diameter 37.7mm x 160mmL x 16t)
 1set Bearing separator & bolts, SCM415, capacity 75-105mm
 2pc Main rod (8"x1.75p)
 2pc Extension rod (8"x1.75p)
 1pc Beam



KT Code	Model	Weight (g)	Price
F131-66601	66601	7600	6,270.-

Hydraulic bearing separator puller set ชุดงานประเภทยึด H-Type 105-150 มม.

- 1pc Hydraulic ram (SCM420 ϕ 37.7mm)
- 1 set Bearing separator & bolts (SCM415 Drop forged HRC 42-45) Capacity: 105-150mm
- 2pc Main rod (Hex bar 21mm x 10'L x ϕ 5/8" - 11 NC)
- 2pc Extension rod (Hex bar 21mm x 10'L x ϕ 5/8" - 11 NC)
- 1pc Beam (Ductile)
- 1pc Adaptor (Carbon steel)
- Packing: Metal case

KT Code	Model	Weight (kg)	Price
F131-66613	66613	12	11,850.-



Pipe torque wrench ประแจทอร์คจับทื่อ



KT Code	Model	Torque Nm	L (mm)	Weight (g)	Price
F131-647P210	647P210	40-210	590	3000	7,600.-
F131-647P350	647P350	70-350	825	3700	9,320.-
F131-647P500	647P500	100-500	920	4300	14,720.-

Pressure screw separator puller set ชุดงานประเภทยึด 75-105 มม.

- 1 set Bearing separator & bolts (SCM415 Drop forged HRC 42-45) Capacity: 75-105mm
- 2pc Main rod (Hex bar 19mm x 8'L x ϕ 15.24mm - 1.75P)
- 2pc Extension rod (Hex bar 19mm x 8'L x ϕ 15.24mm - 1.75P)
- 1pc Beam (S45C)
- 1pc Forcing screw (ϕ 18.65 - 10T/inch x 292mmL S45C)
- 1pc Central nut
- Packing: Metal case

KT Code	Model	Weight (kg)	Price
F131-66612	66612	9	6,170.-

Pressure screw separator puller set ชุดงานประเภทยึดแบบสลึง 75-105 มม.

Contents:
 1pc Central bolt
 1set Bearing separator & bolts, SCM415, capacity 75-105mm
 2pc Main rod (8"x1.75p)
 2pc Extension rod (8"x1.75p)
 1pc Beam
 1pc Nut



KT Code	Model	Weight (g)	Price
F131-66602	66602	8650	5,370.-

Two sets bearing separator kit ชุดงานประเภทยึดคู่ 30-50 มม. / 50-75 มม.

- 2 sets Bearing separator & bolts (SCM415 Drop forged HRC 42-45) Capacity: 30-50mm Capacity: 50-75mm
- 4pc Main/Extension rod (Hex bar 17mm x 127mmL x 3/8" - 16T)
- 4pc Main/Extension rod (Hex bar 14mm x 102mmL x 3/8" - 16T)
- 1pc Beam (S45C)
- 1pc Forcing screw (ϕ 9/16" - 10T/inch x 175mmL S45C)
- Packing: Blow mold case



KT Code	Model	Weight (g)	Price
F131-66610	66610	4600	5,440.-



Bearing separator งานประกบลูกปืน



KT Code	Model	Capacity (mm)	Bolt	Hole	Price
F131-666105	666105	75-105 (3" to 4-1/2")	16mm x 165mmL x 5/8" x 18t	11.2mm x 1/2" x 12t	1,920.-
F131-666150	666150	105-150 (4" to 6")	19mm x 260mmL x 3/4" x 16t	8.2mm x 3/8" x 16t	4,870.-
F131-666300	666300	35-300	26mm x 355mmL	3/4" x 10P	16,680.-

2-in-1 Bearing Puller (2 Jaws) ชุดมือถอดลูกปืน 2 ขา 2-in-1

- Inside diameter 38mm ~ 120mm



KT Code	Model	Weight (g)	Price
F131-66621	66621	5400	8,080.-

Mini bearing separator assembly ชุดถอดและงานประกบลูกปืน

Bearing separator inside:

- Capacity 3/8" - 1-1/4" (10mm to 30mm)
- Bolt (6.3mm x 83mmL x 1/4" x 20UNC)
- Body thread 3/8" x 20UNC

Pull out the bearing with the H-type beam and bolts.



KT Code	Model	Weight (g)	Price
F131-66614	66614	7500	2,190.-

2-in-1 Bearing Puller (3 Jaws) ชุดมือถอดลูกปืน 3 ขา 2-in-1

- Inside diameter 12mm ~ 38mm



KT Code	Model	Weight (g)	Price
F131-66620	66620	3050	4,350.-

Internal & external puller set ชุดมือถอดลูกปืนแบบจับนอกและจับใน

- Drop forged chrome vanadium steel

Contents:

- 1-Internal small (Capacity: 15-30mm)
- 1-Internal large (Capacity: 30-80mm)
- 1-External (Capacity: 15-80mm)



KT Code	Model	Weight (g)	Price
F131-66431	66431	5300	7,070.-

Blind hole bearing puller ชุดมือถอดลูกปืนและพู่เสย

- Two function bearing remover for puller and slide hammer.
- One slide hammer, 62mm tailpipe expanders and pullers for 8mm-32mm.







KT Code	Model	Weight (g)	Price
F131-910T1	910T1	3500	9,420.-



เหล็กชุดและประแจจากรุ่น

Bearing puller

ตัวดูดลูกปืนและเฟืองเกียร์

KT Code	Model	Capacity (mm)	Weight (g)	Price
F131-666A035	666A035	19-35	280	1,180.-
F131-666A055	666A055	24-55	783	1,270.-

Thick jaws gear puller

ตัวดูดเฟืองเกียร์แบบปากหนา

- Jaws thickness: 1.5 mm
- Depth: 100mm
- Bearing dimension: 40-90mm





KT Code	Model	Weight (g)	Price
F131-65910	65910	680	1,560.-

Long jaw bearing puller

ตัวดูดลูกปืนปากยาว

- For long distance pulling jobs
- Capacity 10-50mm
- Alloy steel
- Jaw long 300mm (SCM415 drop forged HRC 40-42)
- Drop forged hardened 48°-50°
- Forcing screw (SCM415)
- Stopper cone (S45C)
- Connector (SCM415)





KT Code	Model	Weight (g)	Price
F131-66616	66616	1200	3,180.-

Bearing separator

ชุดเครื่องมือดูดลูกปืน แบบเจาะร่อง ระยะปรับ 20-95 มม.

- This kit is different from other bearing separators. When obstruction is round external dia. and internal dia. of bearing, it can be used on the confined space to damage the protecting cover of bearing and easily remove bearings.
- Adjust range: 20 ~ 95 mm
- Bearing range:
 - 6004 ~ 6010 (Jaw size: Ø6 / 8)
 - 6201 ~ 6206 (Jaw size: Ø5.5 / 6 / 8) ;
 - 6300 ~ 6304 (Jaw size: Ø6 / 8)





KT Code	Model	Weight (g)	Price
F131-66618	66618	800	2,650.-

Pilot bearing puller

ตัวดูดลูกปืนลูกธนู

- Capacity: inside diameter 12mm-38mm, 1/2"~1-1/2"



KT Code	Model	Weight (g)	Price
F131-66619	66619	920	2,070.-

Bearing separator

ชุดเครื่องมือดูดลูกปืน แบบเจาะร่อง ระยะปรับ 35-120 มม.

- This kit is different from other bearing separators. When obstruction is round external dia. and internal dia. of bearing, it can be used on the confined space to damage the protecting cover of bearing and easily remove bearings.
- Adjust range: 35 ~ 120 mm
- Bearing range:
 - 6207 ~ 6211 (Jaw size: Ø11 / 12.5 / 15)
 - 6305 ~ 6308 (Jaw size: Ø11 / 12.5) ;
 - 6403 ~ 6405 (Jaw size: Ø11 / 12.5 / 15)



KT Code	Model	Weight (g)	Price
F131-66618M	66618M	1700	4,080.-



Unique bearing removal kit ชุดเครื่องมือถอดลูกปืน

- Three-way operation allows use with traditional bearing separator, internal or external legs or bearing race separator. Bearing race separator application makes this kit ideal for use on "blind" mounted bearings where rear of bearing is not accessible.
- Adjust range: 35 ~ 120 mm
- Bearing range: 6207 ~ 6211 (Jaw size: Ø11 / 12.5 / 15)
6305 ~ 6308 (Jaw size: Ø11 / 12.5) ;
6403 ~ 6405 (Jaw size: Ø11 / 12.5 / 15)
- Beam: 30-50 mm
- Legs: 30-90 mm



KT Code	Model	Weight (g)	Price
F131-66618MA	66618MA	2700	5,350.-

21pc Go-through ratchet socket set (SAE&MM)

- For a wide range of pulling jobs, including: bearings, alternators, generators, power steering and crankshaft pulleys, timing gears, and harmonic balancers.
- Spread: 2-3/8" to 3-3/8" & 3-1/2" to 5-1/2"
- Reach: 1-5/8" & 1-3/4"
- Set includes drop-forged components, which can be used in a variety of combinations.



KT Code	Model	Weight (g)	Price
F131-666A03	666A03	4120	6,730.-

Differential side bearing puller ชุดเครื่องมือถอดลูกปืนเฟืองท้าย

- Used to removing differential side carrier bearing. Works on a wide variety of cars and light-duty trucks.
- Includes four step plate adapters to fit carrier bearings.



KT Code	Model	Weight (g)	Price
F131-666A01	666A01	2250	4,420.-

Hydraulic gear puller set ชุดงานประยกบลูกปืน + ขาเลื่อน

For agriculture/ Machine/ Garage/ Industry use

- Hydraulic ram (SCM420 Ø37.7mm)
- Twin Head 1pc
- Triple head 1pc
- Ram nut (SCM415 HRC 42-45)
- Beam (S45C)
- 4" Leg 3 pcs (SCM415 HRC 42-45)
- 6" Leg 3 pcs (SCM415 HRC 42-45)
- 8" Leg 3 pcs (SCM415 HRC 42-45)
- Sent pop (Ø1" × L30mm S45C)
- Ram extension rod (Ø1" × L2" S45C)
- Ram extension rod (Ø1" × L2" S45C)
- Main rod 2 pc (Hex bar 19mm × L8" × Ø15.24mm-1.75P)
- Extension rod 2pc (Hex bar 19mm × L8" × Ø15.24mm-1.75P)
- Bearing separator Spread range 75-150mm (SCM415 Drop forged HRC 42-45)



KT Code	Model	Weight (kg)	Price
F131-66622	66622	16.5	14,350.-

A/C Clutch puller set ชุดเครื่องมือถอดลูกปืนคลัทช์ คอมเพรสเซอร์แอร์

- Versatile 2-jaw puller designed to remove stubborn A/C clutch pulleys.
- Features two sets of jaws, a crossbar with three settings for correct spread, and an adjustable yoke to keep jaws tight.
- Spread of jaws: 3" to 5". Reach of jaws: 1" to 2-1/4".



KT Code	Model	Weight (g)	Price
F131-666A02	666A02	2200	4,420.-

6 ways multi purpose hydraulic gear puller ชุดงานประยกบลูกปืน+ขาเลื่อนไฮดรอลิก

- Hydraulic ram (SCM420 Ø37.7mm)
- Combination cross head (S45C)
- Combination leg 3pcs (SCM415 Drop forged HRC 42-45)
- Steel Plate 6 pcs
- Screw/ Nut /Washer 6pcs
- Sent pop (Ø1" × L30mm S45C)
- Ram Extension rod (Ø1"× L2"S45C)



KT Code	Model	Weight (g)	Price
F131-66623	66623	4800	7,780.-



เหล็กชุบและประแจจากรุ่น

Micro 3" jaw lock puller 3 ขาคูดึง 3"

- Forcing screw (SCM415)
- Chuck (SCM415)
- 3" Jaw 3pieces (SCM415)

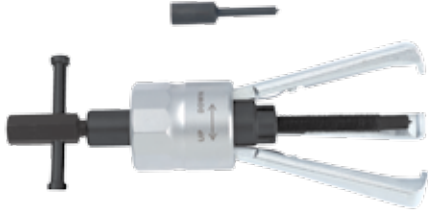

KT Code	Model	Weight (g)	Price
F131-66617	66617	1420	3,170.-

Outside puller 3 ขาคูดึง แบบจับนอก

- Spread: 7-140 mm
- Depth: 147 mm



KT Code	Model	Weight (g)	Price
F131-66625	66625	1800	5,330.-

Inside puller 3 ขาคูดึง แบบจับใน

- Spread: 23-130 mm
- Depth: 140 mm



KT Code	Model	Weight (g)	Price
F131-66624	66624	1600	5,910.-

Universal puller set ชุด 3 ขาคูดึง

- 1 beam 2-arm
- 1 beam 3-arm
- 9 pulling legs, length 100 / 200 / 250 mm
- 2 spindle



KT Code	Model	Weight (g)	Price
F131-66626	66626	7200	12,110.-

Hydraulic 6" jaw lock puller 3 ขาคูดึง 6"

- Hydraulic ram (SCM420)
- Chuck (SCM415)
- 6" Jaw 3pieces (SCM415)



KT Code	Model	Weight (g)	Price
F131-66617A	66617A	5500	7,320.-

Universal puller set ชุดเครื่องมือคูดึงปืนไฮดรอลิก

- 1 beam 2-arm
- 1 beam 3-arm
- 9 pulling legs, length 150 / 220 / 300 mm
- 1 spindle

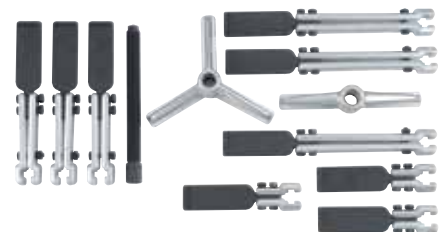

KT Code	Model	Weight (kg)	Price
F131-66627	66627	12.4	20,830.-

เหล็กชุบและประแจทอร์ค



2&3 Jaws gear puller set

ชุดตัวดูด 3 ขา

- 1 beam with 2-arm and 3-arm
- 6 pulling legs, length 130 / 200 mm
- 1 spindle (219mm)



KT Code	Model	Weight (kg)	Price
F131-66628	66628	12.4	6,380.-

11pc Head-interchangeable torque wrench & spanner set

ชุดประแจทอร์คและประแจปากตาย ชนิดเปลี่ยนหัวได้ 11 ชิ้น

Contents:



- 647B210 1- 40~210Nm Torque wrench (14mm x 18mm)
- 647H414 1- 1/2"DR. Ratchet head (24 teeth) (14mm x 18mm)
- 68514 13...30 9- Spanner head (14mm x 18mm)
13; 14; 15; 17; 19; 22; 24; 27; 30 mm



KT Code	Model	Weight (kg)	Price
F131-64705	64705	4.425	10,980.-

Gear puller - 2 Jaw

2 ขาคูดเฟืองเกียร์

KT Code	Model	Size	Capacity (tons)	Spread (mm)	Price
F131-6590103	6590103	3"	2	40/75	760.-
F131-6590104	6590104	4"	4	50/100	1,160.-
F131-6590106	6590106	6"	6	70/150	1,950.-

Torque handle fittings



อะไหล่หัวปากตาย (ขนาด 14x18 มม.)



KT Code	Model	Size (mm)	Price
F131-6851417	6851417	17	760.-
F131-6851419	6851419	19	760.-
F131-6851424	6851424	24	760.-
F131-6851427	6851427	27	760.-
F131-6851429	6851429	29	760.-
F131-6851430	6851430	30	760.-

Gear puller - 3 Jaw

3 ขาคูดเฟืองเกียร์





KT Code	Model	Size	Capacity (tons)	Spread (mm)	Price
F131-6590203	6590203	3"	3	40/75	1,260.-
F131-6590206	6590206	6"	9	70/150	2,740.-



เหล็กชุบและประแจทอร์ค

Flexible hex nut driver ด้ามไขควงอ่อน



KT Code	Model	Size	Blade	Over	Weight (g)	Price
F131-648055	648055	5.5	160	270	190	290.-
F131-64806	64806	6	160	270	192	290.-
F131-64807	64807	7	160	270	196	290.-
F131-64808	64808	8	160	270	198	290.-

Extendable air blow gun ปืนฉีดลม ก้านหมุน-ขยายได้

- Special extendable tube and swivel angle can work in any kinds of area.

Specification:

- Length: 7~12" (9U0204) / 13"~24" (9U0205)
- Working pressure: 78~120 PSI / 5~8 KGS
- Thread type: 1/4"

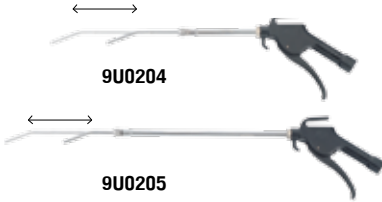

Extendable

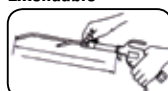

Revolvable



KT Code	Model	Weight (g)	Price
F131-9U0204	9U0204	283	770.-
F131-9U0205	9U0205	260	840.-

Extra long screwdriver ไขควงชนิดก้านยาวพิเศษ



KT Code	Model	Tip	Size	Blade	Over	Weight (g)	Price
F131-65511	65511	PH.1	350	450	75	240.-	
F131-65512	65512	PH.2	350	450	75	260.-	
F131-65512L	65512L	PH.2	400	515	215	430.-	
F131-655304	655304	4	300	400	65	190.-	
F131-655305	655305	5	300	400	65	220.-	
F131-655306	655306	6	300	400	65	250.-	
F131-655308	655308	8	300	400	70	290.-	
F131-6553065L	6553065L	6.5	400	515	215	440.-	

4pc Stud extractor set ชุดน๊อคซ์ขันสตัด

- For remove threaded, broken, rusted, stripped or smooth studs.

5042 Contents:
4pc Stud extractor set (MM)
818 06...12 4-Stud extractor 6; 8; 10; 12 mm

5042S Contents:
4pc Stud extractor set (SAE)
818 1.4...7.16 4-Stud extractor 1/4"; 5/16"; 3/8"; 7/16"



KT Code	Model	Weight (g)	Price
F131-5042	5042	790	1,390.-

Air blow gun ปืนฉีดลม

It is suitable for removing and cleaning any kinds of chip.
Specification:

- Length: 4" (9U0202) / 13" (9U0203)
- Working pressure: 78~120 PSI / 5~8 KGS
- Thread type: 1/4"

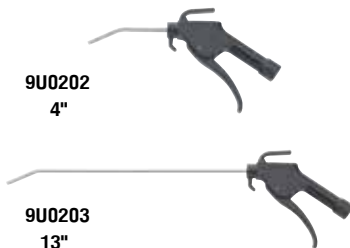

KT Code	Model	Weight (g)	Price
F131-9U0202	9U0202	167	480.-
F131-9U0203	9U0203	240	620.-

Stud extractor ลูกน๊อคซ์ขันสตัด

- For remove threaded, broken, rusted, stripped or smooth studs.



KT Code	Model	Drive	Size	mm	Weight (g)	Price
F131-81805	81805	3/8"	5	60	127	520.-
F131-81806	81806	1/2"	6	60	132	520.-
F131-81807	81807	1/2"	7	60	130	520.-
F131-81808	81808	1/2"	8	60	130	520.-
F131-81810	81810	1/2"	10	68	186	550.-
F131-81812	81812	1/2"	12	68	184	550.-
F131-81814	81814		14	68	253	650.-
F131-8183.16	8183.16	3/8"	3/16"	60	126	520.-
F131-8181.4	8181.4	1/2"	1/4"	60	126	520.-
F131-8185.16	8185.16	1/2"	5/16"	60	124	520.-
F131-8183.8	8183.8	1/2"	3/8"	68	176	550.-
F131-8187.16	8187.16	1/2"	7/16"	68	172	550.-
F131-8181.2	8181.2	1/2"	1/2"	68	196	650.-

เครื่องมือทั่วไป

Stud extractor ลูกบ็อกซ์ถอนสตั๊ด

- Socket 1/2" DR. Stud Extractor.
- For remove threaded, stripped, rusted, broken and smooth studs.
- Stud range: 6 - 19mm (1/4" - 3/4")



KT Code	Model	Weight (g)	Price
F131-818A	818A	560	1,200.-

8pc Screw extractor set ชุดสกรูถอนสตั๊ด 8 ชิ้น

- Size: 1/8" - 1/4" (M3-6)
1/4" - 5/16" (M6-8)
5/16" - 7/16" (M8-11)
7/16" - 9/16" (M11-14)
9/16" - 3/4" (M14-18)
3/4" - 1" (M18-25)
1" - 1-1/8" (M25-28)
1-1/8" - 1-1/4" (M28-32)



63006

KT Code	Model	Weight (g)	Price
F131-63006	63006	830	2,560.-

10pc Combination extractor and drill set ชุดสกรูถอนสตั๊ด 10 ชิ้น

- Contents five spiral extractors #1 through #5 and five mechanic's length hess drill, removes bolts and screws up to 5/8".
- Left hand extractors with right hand drills.

Contents:
Hess drill size, 5/64", 7/64", 5/32", 1/4", 19/64"
Screw extractor size, 5/64", 7/64", 5/32", 1/4", 19/64"



KT Code	Model	Weight (g)	Price
F131-910U1	910U1	333	1,510.-

Threaded coil-insert repair kit ชุดเครื่องมือซ่อมเกลียวใน



KT Code	Model	Size	pc in set	Weight (g)	Price
F131-929U2	929U2	M6 x 1.0	29	310	1,970.-
F131-929U3	929U3	M8 x 1.25	29	390	2,190.-

5pc Screw extractor set ชุดสกรูถอนสตั๊ด 5 ชิ้น

- Size: 1/8" - 1/4" (M3-6)
1/4" - 5/16" (M6-8)
5/16" - 7/16" (M8-11)
7/16" - 9/16" (M8-14)
9/16" - 3/4" (M14-18)



63005



63005B

KT Code	Model	Weight (g)	Price
F131-63005	63005	137	560.-
F131-63005B	63005B	137	480.-

8pc Axle spindle rethreading set ชุดเครื่องมือซ่อมเกลียวสตั๊ด 8 ชิ้น

- 8pcs thread restoring die set is used to clean or repair axle threads on spindles.
- Use with 1-1/4" socket or wrench.
- Size: M24x1.50; M24x2.00; M22x1.00; M22x1.50; M20x1.50; M20x1.25; 3/4"x20UNEF; 13/16"x20UNEF



KT Code	Model	Weight (g)	Price
F131-67001	67001	600	2,030.-



เครื่องมือทั่วไป

4pc Nut splitter set

ชุดเครื่องมือตัดน็อตตัวเมีย 4 ชิ้น

Contents:
 6720912 1pc 5/16" to 1/2" (9-12mm)
 6721216 1pc 1/2" to 5/8" (12-16mm)
 6721622 1pc 5/8" to 7/8" (16-22mm)
 6722227 1pc 7/8" to 1-1/8" (22-27mm)





KT Code	Model	Weight (g)	Price
F131-672	672	1540	3,760.-

Soft face hammer

ม้อนหัวอ่อนค้ำไม้

- Hammer head: 1 yellow PU+1 white Nylon
- Handle: natural color hickory



KT Code	Model	Weight (g)	Price
F131-616A400	616A400	415	1,670.-

External & internal restorer file

แท่งล้างเกลียว

- Restorer tool for renewing damaged thread on bolt, stud, axle or shaft of any diameter. File both right and left hand threads.
- Designed for use in hidden & narrow area.
- Description pitch sizes:
 9U1101
 Metric File :0.80-1.00-1.25-1.50-1.75-2.00-2.50-3.00





KT Code	Model	Weight (g)	Price
F131-9U1101	9U1101	164	1,420.-

Soft face hammer

ม้อนหัวอ่อน

- Hammer head: black TPR & transparent yellow acetate head
- Handle: 1.4mm harden tubular steel handle, PVC ring & A type PVC grip



KT Code	Model	Weight (g)	Price
F131-616A700	616A700	842	1,400.-

Recoilless hammer (head-replaceable)

ม้อนหัวอ่อน

- Steel handle with positive plastic grip.
- PU-material strike faces.
- Both strike faces can be repeatedly changed if broken.



KT Code	Model	l (mm)	Weight (g)	Price
F131-616A025	616A025	25	389	1,150.-
F131-616A030	616A030	30	435	1,250.-
F131-616A035	616A035	35	505	1,330.-
F131-616A040	616A040	40	606	1,620.-
F131-616A045	616A045	45	865	1,740.-
F131-616A050	616A050	50	952	1,820.-
F131-616A055	616A055	55	1038	1,980.-
F131-616A060	616A060	60	1125	2,100.-

10pc Tubing cutter & double flaring tool set

ชุดเครื่องมือตัดและบานท่อ 10 ชิ้น

Contents:
 1-Flaring tool
 1-Flare bar
 Size of flare bar and adapters:
 S.A.E.: 3/16", 1/4", 5/16", 3/8", 7/16", 1/2" & 5/8"
 1-Heavy duty tube cutter: 1/8"-1/18"
 • This 2-in-1 flaring tool set is designed to withstand the high pressures necessary to double flare soft steel tubing, as well as, single flare soft copper, aluminum and brass tubing. Automotive 45°

656AM Changed item
 1-Flare bar
 Size of flare bar and adapters:
 Metric: 4-4.75-6-8-10-12-14mm
 1-Heavy duty tube cutter: 4-28mm



KT Code	Model	Weight (g)	Price
F131-656AM	656AM	-	3,370.-

เครื่องมือมือทั่วไป

180° 3-in-1 Tube bender

คีมดัดท่อ 180° 3-in-1

- Quality aluminum body
- Three size tube bender

Inch: 1/4", 5/16", 3/8"
Metric: 6mm, 8mm, 10mm



KT Code	Model	Weight (g)	Price
F131-653180	653180	545	890.-

Tubing bending pliers

คีมดัดท่อ

- For bending brass, copper, aluminum and steel tubing.
- Tubing bender pliers feature one rollers.
- One roller accepts 3/16" / 1/4" / 5/16" / 3/8" (4.8 / 6.4 / 7.9 / 9.5mm) O.D. tubing.



KT Code	Model	Weight (g)	Price
F131-65305	65305	2500	1,210.-

Hydraulic flaring tool kit

ชุดเครื่องมือบานท่อ ระบบไฮดรอลิก

- Use in-site on the vehicle and suitable for producing SAE (3/16" & 1/4") and DIN 45 degree (3/16" & 1/4") flares.
- Capable of working on steel brake pipes.
- Complete with reamer for de-burring.
- 4.75; 5; 6 mm



KT Code	Model	Weight (g)	Price
F131-656BM	656BM	2584	10,870.-

Professional tubing cutter

มีดตัดท่อ 4-28mm

- Solid and durable
- Aluminum alloy body
- High grade SUJ2 steel blade
- With deburring reamer.
- Capacity: 4-28mm (1/8"-1-1/8")
- For copper, brass and aluminum tubing.





KT Code	Model	Weight (g)	Price
F131-65604	65604	280	910.-

Breakline bending pliers

คีมดัดปลายท่อ

- SIZE: 3/16", 1/4"

KT Code	Model	Weight (g)	Price
F131-65303	65303	420	1,850.-

Ratchet tube cutter

มีดตัดท่อ

*Quick and easy ratchet mechanism make it easy and comfortable to use even in narrow spaces.
*Pipe thickness up to 3mm.



KT Code	Model	(mm)	Weight (g)	Price
F131-65631	65631	8-28	460	1,810.-
F131-65632	65632	28-67	1080	6,600.-

เครื่องมือทั่วไป



Inside/ Outside deburring tool มีดลบคมปากท่อนอก-ใน

- 3/16"-1 1/2"O.D. plastic body



KT Code	Model	Weight (g)	Price
F131-65304	65304	35	530.-

3-in-1 Magnetic flexible pickup tool with light & mirror กระจกส่องจุดอับ 3-in-1

- Positive action turn on / off switch
- Magnetic pick-up 3.5lbs. (1.6kgw)
- Flexible shank of dia. 8.5mm and length 455mm(17-7/8")
- Oval glass mirror 25 x 50mm (1-1/8"x2")
- Replaceable bulb (2.2V, 0.25A)
- Inspection light is operated with 2pc AA batteries (not included)



KT Code	Model	Weight (g)	Price
F131-617L	617L	210	920.-

Exhaust pipe and tubing cutter มีดตัดท่อแบบโซ่

- Cuts thin walled steel and copper tubing from Ø20mm to Ø75mm (3/4"-3").
- Cuts quickly and easily.
- Fitted with 7 cutting blades for fast, clean cutting.



KT Code	Model	Weight (g)	Price
F131-65603	65603	586	1,890.-

Midi EZ-release magnetic pick-up แม่เหล็ก

- 110x110x190mm
- Capacity: 10 LBS (4.54 kg)

- Functions:**
- Easy pick-up and release of metallic materials.
 - Just squeeze the handle to quickly release material.



KT Code	Model	Weight (g)	Price
F131-88012	88012	630	570.-

Multi-function magnetic pick-up กระจกส่องจุดอับ

- Magnetic pick-up tool in telescopic extended, maximum 63cm extension.
- Take off the cap of bottom, the needle point head can be used for marking when draw a line or clean the narrow slot and small hole.
- Attach a fully adjustable mirror for inspection.
- All in one handy tool with pocket clip.



KT Code	Model	Weight (g)	Price
F131-617	617	89	480.-

Heavy-duty flexible magnet pick-up tool โซ่คองแม่เหล็กพลังสูง

- Flexible shank diameter 8.5mm; 440mmL
- With plastic PVC grip
- Magnetic Capacity: 3.5Lbs(1.6Kgw)
- Overall length: 535mm(21")



KT Code	Model	Weight (g)	Price
F131-61701	61701	190	750.-



Flexible magnet pick-up tool ไขควงแม่เหล็ก

- Flexible shank diameter 5.0mm; 400mmL
- With plastic PP grip
- Magnetic Capacity: 1.5Lbs(0.7Kgw)
- Overall length: 510mm(20")



KT Code	Model	Weight (g)	Price
F131-61702	61702	150	720.-

Magnetic fender cover ผ้ายางคลุมแก้มรถ แบบแม่เหล็ก

- Size:110cmx56cm
- Front cover made with PVC Sponge leather, backing is TR/BRUSH which does not damage or scratch any surface
- Top row includes STRONG magnets, which attract and stay on any metal surface easily.
- Easy to open and fold into compact size.
- The magnets are removable and replaceable before and after washing the fender cover.



88801 (4 Pockets)



88802 (No Pocket)



KT Code	Model	Weight (g)	Price
F131-88801	88801	980	2,000.-
F131-88802	88802	734	1,910.-

Telescopic magnetic pick-up tool แม่เหล็กตามเสาอากาศ

- 7-section extension rod.
- Length: 135 mm - 65 mm.
- Magnetic capacity: 3.5LBS (1.6kg).
- With pocket clip.



KT Code	Model	Weight (g)	Price
F131-88902	88902	60	590.-

Magnetic fender cover w/o pockets ผ้ายางคลุมแก้มรถ แบบแม่เหล็ก

- Size:80cmx60cm
- Front cover made with PVC Sponge leather, backing is TR/BRUSH which does not damage or scratch any surface
- Top row includes STRONG magnets, which attract and stay on any metal surface easily.
- Easy to open and fold into compact size.
- The magnets are removable and replaceable before and after washing the fender cover.



KT Code	Model	Weight (g)	Price
F131-88803	88803	566	1,550.-

3-Claw pick-up tool มือจับในที่แคบ

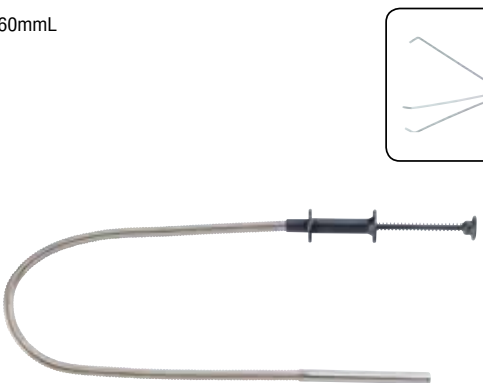
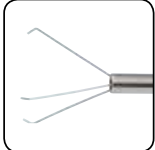

- Length:560mmL

KT Code	Model	Weight (g)	Price
F131-88901	88901	100	810.-

Magnetic fender cover w/o pockets ผ้ายางคลุมแก้มรถ แบบแม่เหล็ก

- Size:108cmx39cm
- Front cover made with PVC Sponge leather, backing is TR/BRUSH which does not damage or scratch any surface
- Top row includes STRONG magnets, which attract and stay on any metal surface easily.
- Easy to open and fold into compact size.
- The magnets are removable and replaceable before and after washing the fender cover.

KT Code	Model	Weight (g)	Price
F131-88804	88804	660	1,550.-



เครื่องมือทั่วไป

Seat cover
ผ้าคลุมเบาะ

- Size: 140mm×70mm



KT Code	Model	Weight (g)	Price
F131-G81	G81	350	1,070.-

Oil suction gun (500 c.c.)
กระบอกเติมน้ำมันเกียร์/เฟืองท้าย

- Perfect for removing or replacing oil in engine/ transmissions/ differentials gearbox sumps/ crankcases, enables easy access to awkward locations.
- Ideal for vehicle & machinery use
- Knurled thick wall barrel for secure grip
- 10" Flexible hose
- Capacity Bulk: 20 oz / 550 cc



KT Code	Model	Weight (g)	Price
F131-887A500	887A500	850	830.-

Steel creeper
กระดานรองนอน

- Six wheels make the movements easily.
- The pillow is removable and replaceable.
- Size: 93×50×12 cm



KT Code	Model	Weight (g)	Price
F131-9U0311	9U0311	8000	7,700.-

Flexible metal funnel
กรวยโลหะสายอ่อน

- Galvanized steel funnel with metallic flexible spout with mesh filter.
- For filling oil easily at inaccessible area.
- Tube Length : 370 mm



KT Code	Model	Weight (g)	Price
F131-887D01	887D01	340	700.-

Steel car seat
เก้าอี้พร้อมชั้นวาง

- Size: 40 × 30 × 30 mm
- Tools not included.



KT Code	Model	Weight (g)	Price
F131-9U0312	9U0312	7500	5,100.-

Jumbo pry bar
ไขควงขจัดทุด

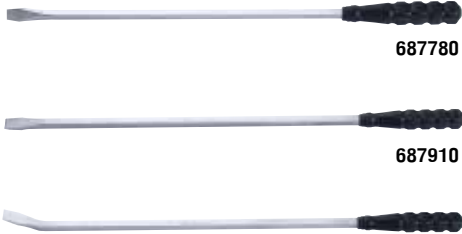

687780
687910
687910A

KT Code	Model	Length	Weight (g)	Price
F131-687780	687780	780mm-30.7"	1085	1,270.-
F131-687910	687910	910mm-36"	1830	2,010.-
F131-687910A	687910A	910mm-36"	1830	2,010.-

เครื่องมือทั่วไป



» Pry bar เหล็กขัด

- Material: S45C

687450
687440

KT Code	Model	Length	Weight (g)	Price
F131-687450	687450	450mm (17.72")	923	980.-
F131-687445	687445	400mm (16")	846	1,050.-

» 4pc Pry bar set ชุดเหล็กขัด 4 ชิ้น

- 904U606 - 6";
- 904U612 - 12";
- 904U616 - 16";
- 904U620 - 20"

KT Code	Model	Weight (g)	Price
F131-904U6	904U6	1700	2,160.-

» 4pc Pry bar ชุดไขควงขัด 4 ชิ้น

- Size: 8"; 12"; 18"; 24"

KT Code	Model	Weight (g)	Price
F131-904U5	904U5	1420	1,280.-

» Brass & nylon scrape brushes แปรง 2 หัว ทองเหลืองและไนลอน

- Length : 75mm

KT Code	Model	Weight (g)	Price
F131-9U3001	9U3001	36	130.-

» Crowbar with crook beak เหล็กขัด 16"

- Bending tool
- Length : 400mm (16")
- Bended head, hexagonal shank

KT Code	Model	Weight (g)	Price
F131-687400H	687400H	465	660.-

» Wire brush แปรงลวด

- Length : 220mm

KT Code	Model	Weight (g)	Price
F131-9U3003	9U3003	64	140.-

เครื่องมือตัวไป





➤ **908G5** P.1-27
Engine timing tool set for VW, Audi

➤ **913G7** P.1-28
Engine timing tool set for VW / AUDI

➤ **906G6** P.1-30
Engine timing tool set for VW

➤ **928G1** P.1-27
Engine timing tool set - VW, Audi, Seat and Skoda

➤ **902G18** P.1-29
Camshaft clamp for VW / AUDI

➤ **904G16** P.1-30
Engine timing tool set for VW / AUDI

➤ **929G1** P.1-28
Timing setting tool set - VW, Audi, Seat and Skoda

➤ **904G15** P.1-29
Engine timing tool set for VW

➤ **914G5** P.1-30
Engine timing tool set for VW / AUDI

➤ **910G5** P.1-28
Engine timing tool set for AUDI

➤ **907G13** P.1-29
Engine timing tool set for VW / AUDI

➤ **908G13** P.1-31
Engine timing tool set for VW

➤ **904G17** P.1-31
3-in-1 Bosch timing tool for VW

➤ **903G14** P.1-32
Camshaft alignment tool

➤ **903G10** P.1-33
Camshaft locking tool

ประเภทเครื่องมือแยกตามยี่ห้อรถยนต์



<p>► 902G13 P.1-31 Camshaft central valve tool for VW / AUDI</p> 	<p>► 9G1209 P.1-32 Camshaft alignment plate for VW, AUDI</p> 	<p>► 902G15 P.1-34 Engine timing tool set for VW / AUDI</p> 
<p>► 9G1210 P.1-32 Camshaft adjusting socket for AUDI</p> 	<p>► 902G6 P.1-33 Camshaft alignment tool</p> 	<p>► 902G16 P.1-34 Engine timing tool set for VW / AUDI</p> 
<p>► 9G1216 P.1-32 Camshaft alignment tool</p> 	<p>► 9G1206 P.1-33 Camshaft locking tool for VW</p> 	<p>► 902G17 P.1-34 Engine timing tool set for VW / AUDI</p> 
<p>► 902G19 P.1-35 Engine timing tool set for AUDI</p> 	<p>► 9G1305 P.1-36 Crank locking pin for AUDI</p> 	<p>► 902G2 P.1-37 Locking tool set for VW, Audi</p> 
<p>► 9G0807 P.1-35 Engine timing tool for VAG</p> 	<p>► 906G4 P.1-36 Timing tool set for VAG 2.0 TDI PD</p> 	<p>► 9G0616 P.1-41 Counter hold tool for VW / AUDI</p> 



➤ **9G1302** P.1-35
AUDI crank locking pin



➤ **9G1208** P.1-36
Crankshaft locking tool



➤ **9G0607** P.1-41
VW, AUDI belt pulley holder



➤ **9G1303** P.1-35
VW/AUDI crank locking pin



➤ **9G1301** P.1-36
Crankshaft locking tool for VW



➤ **9G0608** P.1-41
VW, SEAT belt pulley holder



➤ **903G15** P.1-50
Adjusting tensioner belt set



➤ **9G0705** P.1-45
Reaction wrench (1/2" DR.)



➤ **62530** 00vw
Hose clamp pliers



➤ **903G8** P.1-50
Belt tension locking pins VW / AUDI / TDI PD engines



➤ **34914010V** P.1-91
M10S Cylinder head bolt tool



➤ **61925** P.1-110
Oil lter drain tool (VW)



➤ **902G4** P.1-50
Tensioner adjusting tool



➤ **904T5** P.1-8
4pc VW, AUDI ignition coils puller set



➤ **912G6** P.1-76
VW, AUDI Diesel & gas injection remover tool (TDI & FSI)



ประเภทเครื่องมือแยกตามยี่ห้อรถยนต์



9G0704 P.1-44
Reaction wrench

907T6 P.3-27
Bush remover / installer for VW

908T7 P.3-27
Rear axle bush insertion tool for VW / AUDI

9G0208 P.1-54
Hose clamp pliers (for VW, AUDI 2.0)

905T4 P.3-27
5pc VW, AUDI Rear suspension tool

9G0711 P.1-114
Fuel pump wrench

904T1 P.3-49
Drive nut set

917T3 P.3-28
Wheel hub and wheel bearing extraction & installation set for VW-T5









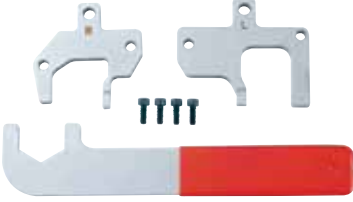

9T0205 P.3-63
VW Automatic transmissions socket

921T1 P.3-28
21pc Compact wheel hub/bearing kit , 62mm, 66mm, 72mm

914B1 P.3-9
Brake calliper guidance thread repair set

ประเภทเครื่องมือแยกตามยี่ห้อรถยนต์

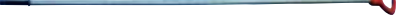

<p>➤ 904G18 P.1-25 Engine timing tool set for BENZ M271</p> 	<p>➤ 9G1215 P.1-27 BENZ ywheel locking tool</p> 	<p>➤ 9G0202 P.1-44 Reaction tool</p> 
<p>➤ 907G4 P.1-26 BENZ Camshaft alignment tool</p> 	<p>➤ 9G0701 P.1-43 65mm Single-ended open wrench</p> 	<p>➤ 674 P.1-46 2pc M10 Alternator tools</p> 
<p>➤ 9G1218 P.1-26 Engine timing tool set for BENZ</p> 	<p>➤ 9G0702 P.1-44 Reaction wrench (with 3 holes)</p> 	<p>➤ 678 P.1-47 2pc T50 Alternator tools</p> 
<p>➤ 906G7 P.1-26 Engine timing tool set for BENZ</p> 	<p>➤ 9G0707 P.1-44 BENZ Fan belt service wrench</p> 	<p>➤ 907G11 P.1-75 Injector puller set for Mercedes CDI</p> 
<p>➤ 9G1803 / 9G1804 P.1-112 Transmission oil gauge</p> 	<p>➤ 903G17 P.1-76 Injector nozzle extractor with spindle</p> 	<p>➤ 62820 P.3-42 1/2" DR. BENZ (W163/W164) Pin wrench socket</p> 



<p>9G1805 / 9G1806 P.1-112</p> <p>Oil gauge</p> 	<p>909G5 P.1-76</p> <p>Injector extractor with slide hammer for DB CDI-engines</p> 	<p>9B0305 P.3-5</p> <p>BENZ Parking brake installer</p> 
<p>903U2 P.1-114</p> <p>3pc Benz fuel tank cap wrench</p> 	<p>9G0121 P.1-77</p> <p>33 Teeth socket diesel injection pump for Mercedes</p> 	<p>902B1 P.3-22</p> <p>2pc Wheel stud alignment guide tool set</p> 
<p>903G19 P.1-74</p> <p>Diesel injector nozzle extractor set</p> 	<p>9G0122 P.1-77</p> <p>Diesel pre-chamber collar nut socket for Mercedes</p> 	<p>902B2 P.3-23</p> <p>2pc Wheel stud alignment guide tool set</p> 
<p>908B3 P.3-23</p> <p>8pc Wheel stud alignment guide tool set</p> 	<p>9T0305 P.3-63</p> <p>Clutch spring compressor</p> 	<p>9T0310 P.3-24</p> <p>BENZ (W202, W170) Lower control arm bushing remover / installer</p> 
<p>9T0206 P.3-19</p> <p>Wheel nut socket for Mercedes-Benz</p> 	<p>9T0307 P.3-23</p> <p>BENZ Bush remover / installer</p> 	<p>9T0311 P.3-24</p> <p>BENZ Axles wheel bearing extractor / installer</p> 



905T3 P.3-47
Spring compressor for Mercedes

9T0308 P.3-24
BENZ (W140) Lower control arm bushing remover / installer

9T1401 P.3-49
BENZ (W203) Strut nut socket

9T0304 P.3-50
BENZ W220 Shock absorber service tool set

9T0309 P.3-24
BENZ (W210) Lower control arm bushing remover / installer

9T1402 P.3-50
BENZ (W220) Strut nut socket

905T7 P.3-41
5pc 1/2"DR. Drive tooth socket for Mercedes

905T10 P.3-41
Ball-joint installer/ remover for BENZ (W220/W211/W230)

927T1 P.3-29
Professional wheel bearing tool set for BENZ

9T1407 P.4-1
BENZ Axle nut socket 95mm

9T1408 P.4-2
BENZ Rear axle nut socket 105-125mm

9T1426 / 9T1427 P.4-2
Benz & Man Rear axle nut socket 80-95mm / 95-115mm

9T1426 9T1427





9T1425 P.4-3
BENZ & MAN Clamp nut socket 60 mm

9T1424 P.4-3
BENZ & MAN Clamp nut socket 56 mm

6281842 P.4-3
3/4" DR. BENZ & MAN Pitman arm puller 42mm

ประเภทเครื่องมือแยกตามยี่ห้อรถยนต์



<p>905G1 P.1-20 BMW (M52, M54, M56) Timing tool kit</p> 	<p>9G1212 P.1-21 BMW Camshaft alignment tool</p> 	<p>913G6 P.1-22 Engine timing tool set for BMW M41, M51, M47, M57</p> 
<p>9G2701 P.1-20 BMW Double vanes setup bracket M50-TU</p> 	<p>9G1213 P.1-21 BMW (M42, M50) Camshaft alignment tool</p> 	<p>905G17 P.1-22 Engin timing tool set for BMW M47</p> 
<p>907G6 P.1-20 Timing tool kit (BMW MINI)</p> 	<p>9G1214 P.1-21 BMW (M60, M62) Camshaft alignment tool</p> 	<p>904G11 P.1-23 Diesel engine timing tool set for BMW N47/N47S</p> 
<p>908G3 P.1-21 BMW Camshaft alignment tool kit</p> 	<p>9G1207 P.1-22 BMW Sprocket extractor / installer</p> 	<p>908G9 P.1-23 Engine timing tool set for BMW N42, N46, N46T</p> 
<p>918G3 P.1-23 Engine timing tool set for BMW N42/ N46</p> 	<p>905G12 P.1-25 Engine timing tool set for BMW, Mini,Citroen, Peugeot</p> 	<p>9G0717 P.1-112 Oil cooler line pliers</p> 

ประเภทเครื่องมือแยกตามยี่ห้อรถยนต์



<p>➤ 906G5 P.1-24 Engine timing tool set for BMW N40/ N45/N45T</p> 	<p>➤ 9G0602 P.1-43 BMW Pulley holder</p> 	<p>➤ 9G0718 P.1-116 BMW line disconnect tool</p>  <p>9G0718 9G0719</p>
<p>➤ 912G5 P.1-34 Engine timing tool set for BMW N51/ N52/N53/N54</p> 	<p>➤ 674 P.1-46 2pc M10 Alternator tools</p> 	<p>➤ 908G11 P.1-75 Diesel injectors remover for BMW</p> 
<p>➤ 905G19 P.1-34 Engine timing tool set for BMW N62 / N73</p> 	<p>➤ 54615012B P.1-92 1/2" DR. 150mm Cylinder head bolt tool (E12)</p> 	<p>➤ 905G15 P.1-25 Fly wheel holder tool for BMW</p> 
<p>➤ 9T0313 P.3-25 BMW (E30, E36, E46) Bush extractor</p> 	<p>➤ 908T3 P.3-25 8pc BMW (E30, E36) Ball joint remover / installer</p> 	<p>➤ 903T5 P.3-26 BENZ (W203) Strut nut socket</p> 

ประเภทเครื่องมือแยกตามยี่ห้อรถยนต์



905G16 P.1-13
Engine timing tools set for VAUXHALL/OPEL diesel 1.9 CDTI

904G2 P.1-15
Valve camshaft setting tool (GM / OPEL / VAUXHALL up to 1987)

9G0803 P.1-49
Belt tensioning adjuster

920G2 P.1-14
Engine timing Tool set for Opel / Vauxhall

904G5 P.1-15
Timing tool kit (for GM 1.3 CDTI diesel engine)

88442 P.1-68
10pc Deluxe noid lite / IAC test kit plus one bre optic noid lite extension

907G17 P.1-14
Engine timing tool set for Vauxhall/ Opel

908G12 P.1-16
Diesel engine timing tool set for RENAULT, NISSAN, OPEL

907G12 P.1-45
Power steering pump pulley kit

907G18 P.1-14
Engine timing tool set for Vauxhall/ Opel

9G0802 P.1-49
Belt tensioning adjuster

63303 P.1-115
Diesel injection priming tool

908T6 P.3-26
Rear suspension tool for GM VECTRA

65014 P.3-10
1/2"DR. Pentagon socket 14mm

ประเภทเครื่องมือแยกตามยี่ห้อรถยนต์



➤ **905G8** P.1-18
Timing locking tools for FORD

➤ **903G11** P.1-19
FORD flywheel locking tool

➤ **934G1** P.1-38
Engine timing tool set for FIAT

➤ **922G2** P.1-18
Engine timing tool set - Ford, Mazda

65019

➤ **9G1211** P.1-19
Camshaft setting bar & TDC timing pins (Ford / Mazda)

➤ **907G16** P.1-38
Engine timing tool set for FIAT

➤ **911G6/916G5/904G6** P.1-18/19/20
Engine timing tool set for FORD

911G6 916G5 904G6

➤ **907G12** P.1-45
Power steering pump pulley kit

➤ **910G7** P.1-38
Engine timing tool set for Fiat 1.2 8V & 1.4 16V

➤ **63302** P.1-114
Fuel transfer tool

➤ **905T5** P.3-26
Sub frame bush remover (Ford Mondeo)

➤ **61927** P.1-102
Oil liter wrench -27mm

➤ **913T2** P.3-28
Wheel hub and wheel bearing extraction & installation set for Ford / Volvo / Mazda

ประเภทเครื่องมือแยกตามยี่ห้อรถยนต์



RENAULT



PEUGEOT



CITROËN

<p>► 917G1 P.1-16 Engine timing tool set - Renault</p> 	<p>► 903G5 P.1-17 Renault timing kit (DCI engines)</p> 	<p>► 935G1 P.1-37 Engine timing tool set - Peugeot, Citroen</p> 
<p>► 905G20 P.1-16 Engine timing tool set for Renault</p> 	<p>► 907G15 P.1-7 Engine timing tool set for RENAULT 1.8 / 2.0 16V</p> 	<p>► 911G7 P.1-37 Engine timing tool set for CITROEN / PEUGEOT</p> 
<p>► 908G12 P.1-16 Diesel engine timing tool set for RENAULT, NISSAN, OPEL</p> 	<p>► 65019 P.3-10 1/2"DR. Pentagon socket 14mm for RENAULT, PEUGEOT, CITROEN</p> 	<p>► 9G0605 P.1-12 Flywheel holding tool</p> 
<p>► 911G5 P.1-15 Diesel engine locking tool set for Opel / Renault / Nissan</p> 	<p>► 920T2 P.3-29 Professional wheel bearing tool set for RENAULT, PEUGEOT, CITROEN</p> 	<p>► 910G3 P.1-74 Diesel injector nozzle extractor set (PSA HDI engines)</p> 
<p>► 902G5 P.1-17 Timing locking tools</p> 	<p>► 904G13 P.1-73 4pcs Injection nozzle socket</p> 	

Profile



Shyang Yun Tools Co., Ltd ก่อตั้งขึ้นในปี 1984 ที่ประเทศไต้หวัน เป็นผู้ผลิตและส่งออกเครื่องมือช่างมานานร่วม 30 ปี ตั้งแต่เริ่มต้น **Shyang Yun Tools Co., Ltd** ได้มุ่งเน้นผลิตสินค้าจำพวกเครื่องมือช่าง ประเภทลูกบ็อกซ์ ลูกบ็อกซ์ลม ดอกไขควง ไขควง ประแจ สิ้นค้าทั้งหมดผลิตตามมาตรฐาน DIN (มาตรฐานของเยอรมนี) โดยที่เกือบทั้งหมดผลิตเกินมาตรฐานที่ DIN กำหนดไว้ เราสามารถตอบสนองทุกความต้องการในการใช้งานด้วยเครื่องมือหลากหลายประเภทและหลากหลายขนาด

จนกระทั่งในปี 1992 เรามีความชำนาญในการผลิตและมีความมั่นใจในตลาด เราจึงได้ทำแบรนด์ **FORCE** และเริ่มนำ **FORCE** ใต้เป็นที่รู้จักไปทั่วโลก โดยแข่งขันกับแบรนด์ต่างๆ ในยุโรปและอเมริกาซึ่งเป็นคู่แข่งที่แข็งแกร่ง แต่คุณภาพของ **FORCE** ก็ได้พิสูจน์ตัวเอง หลังจากหลายปีของการฝ่าฟัน **FORCE** ได้เป็นที่รู้จักใน 5 ทวีปทั่วโลก จึงปฏิเสธไม่ได้ว่าความสำเร็จของ **FORCE** ได้เกิดขึ้นในยุคศตวรรษใหม่

Shyang Yun Tools Co., Ltd ได้ติดตามการเปลี่ยนแปลงของตลาดที่เกิดขึ้น มองเห็นแนวโน้มในอุตสาหกรรมเครื่องมือช่างและตอบสนองได้อย่างรวดเร็ว พร้อมทั้งแสวงหาข้อได้เปรียบในการแข่งขัน ทั้งในตัวของผลิตภัณฑ์และในองค์กร **Shyang Yun Tools Co., Ltd** ได้รับการรับรองมาตรฐาน ISO 9002 ในปี 1994 และ ISO 9001 ในปี 2003

การพัฒนาอย่างต่อเนื่องในด้านคุณภาพ ความหลากหลายของสินค้า รวมไปถึงการขนส่งและการบริการ ได้นำ **FORCE** ไปสู่การเจริญเติบโตอย่างรวดเร็ว **FORCE** กลายเป็นแบรนด์ที่ได้รับความนิยมไว้วางใจจากผู้ใช้งาน และ **Shyang Yun Tools Co., Ltd** ยังคงสร้างความสัมพันธ์ทางธุรกิจที่แข็งแกร่งในระยะยาวกับลูกค้าทั่วโลก เรามุ่งมั่นและสัญญาว่าจะยึดถือคุณภาพ ความรับผิดชอบ ความซื่อสัตย์และมุ่งมั่นในการให้บริการต่อไป



FORCE®



www.autocorp.co.th



www.ktw.co.th

จัดจำหน่ายโดย: